

Work Smart with Magnets

A comprehensive range of magnetic products
for a multitude of applications



(≤18.00")

400P
(880I

Work Smart with Magnets

With over 100 years of magnetic heritage and over 20,000 product choices, we can help you:-

Hold



Organise

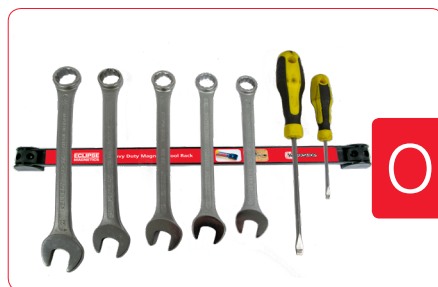

Lock



Collect



Retrieve



Display



Lift



Weld



Measure







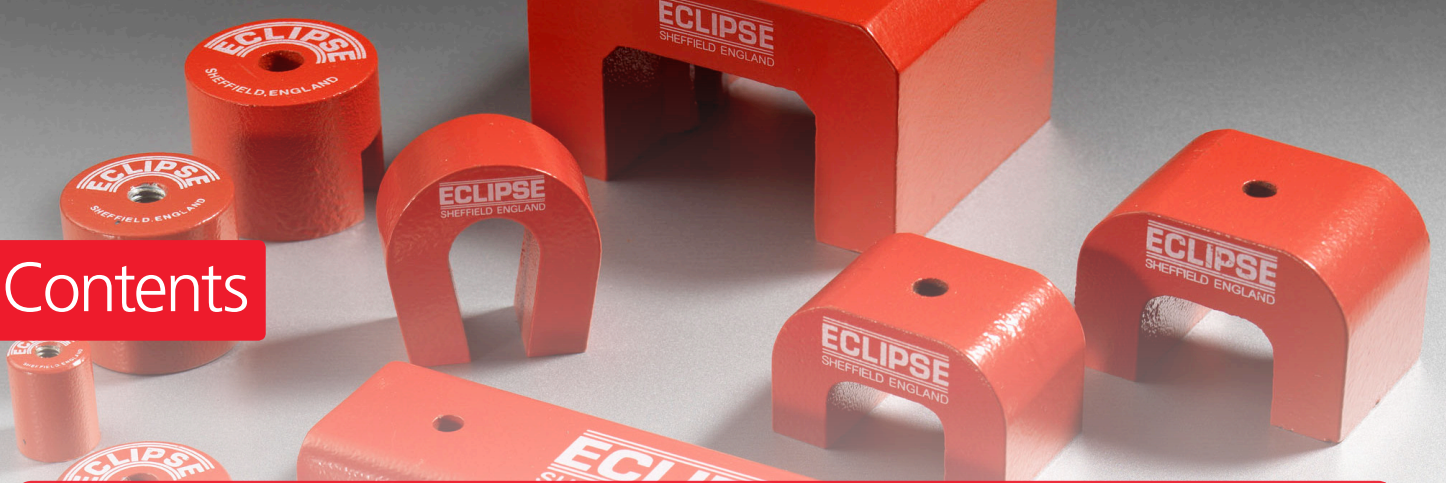

Protect



Contents



		Page
	Over 100 Years of Magnetic Heritage Work Smart with Our NEW Additions	5-6 7
	Alnico Ferrite	10-12 13-14
	Neodymium Alnico Ferrite Samarium Cobalt	16-24 25-26 27-29 30-31
	Energise to Hold Energise to Release Armature Plates	34 35 35
	UltraLift Lifting Handling	38-39 40 41-42
	Retrieval Tools Pick-Up Tools Workshop Tools Mounting/Measurement	44-47 48-50 51-55 56-57
	Magnetic Switchable Welding Aids Magnetic Welding Aids	60-61 62-65

Contents



PRECISION

Workholding	68-71
Mounting/Measurement	72-73
Bases	74
Fitments	75-77
Fitments LED Lamp	78-79



DISPLAY

81-85

Let your business work smart with magnets

Typical industries benefiting from magnets

86-87

Guide to Magnet Materials

Choose the right material for your application

88-89

Customised Magnetic Solutions

We can solve your problem

90



Over 100 Years of Magnetic Heritage

Eclipse Magnetics has a rich history as a pioneer in applying magnetic technology to the **everyday challenges** of industry and commerce. From large complex OEM design projects to simple holding or pick up tasks, our clients can rest assured that **Eclipse Magnetics is definitely a brand to trust for product quality and service support.**



Add Value to Your Portfolio

End users can enjoy the benefits of a high performance, built to last product, whilst our agents and distributors can boost their portfolio and profits by stocking a globally recognised brand.



Problem Solving Solutions

Our range encompasses products for a diverse range of applications. Our knowledge and expertise of magnet materials has enabled us to design problem solving solutions for a diverse range of business sectors including: retail, aerospace, automotive, food processing, precision manufacturing, automation systems and power generation.

Premium Product Quality

Our skilled design and engineering teams set high standards of product design both in terms of performance and affordability. All our manufacturing is carried out under ISO 9001 quality management systems and where relevant, industry specific approvals.



Retail friendly packs



How it all began...

Over 100 Years of Magnetic Heritage

Post-Sales Support

We offer worldwide sales and technical support through our centres in the UK, Canada and China. We also have a worldwide network of approved distribution partners providing local support. Most of our products are available direct from our stock locations for immediate despatch.

Group Support

Eclipse Magnetics are part of the Spear & Jackson Group of companies, a world famous name with over 250 years of manufacturing and commercial success.

Environmental Policy

We are committed to continued improvement in key areas of efficient energy use and waste/pollution minimisation. We also comply with all legislation, regulations and codes of practice relevant to our sector. Our internal systems and procedures are fully accredited to ISO 14001 standards.

Contact Us

For more information about our products you can contact us via:

- +44 (0)114 225 0600
- +44 (0)114 225 0610
- www.eclipsemagnetics.com
- info@eclipsemagnetics.com

Eclipse Magnetics Ltd
Atlas Way, Sheffield, S4 7QQ, England.

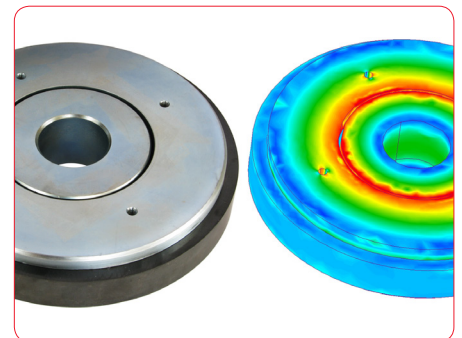

Work Smart with our
NEW additions

NEW

Page
60

NEW Welding Clamps

With switchable feature



Page
48

NEW Pick Up Tools

Safe, convenient pick-up



Page
44

NEW Retrieval Tools

For those awkward jobs in difficult locations



Page
51

NEW Workshop Tools

Simplify everyday challenges

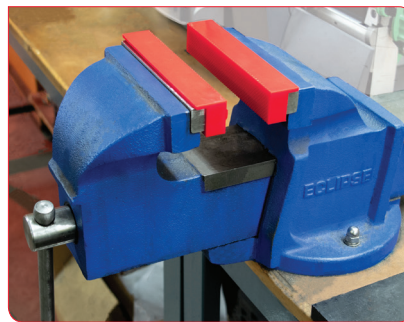

Did you know?

"Legend has it that a Greek shepherd called Magnes discovered magnetism 4000 years ago"



The
world renowned
HERITAGE
range

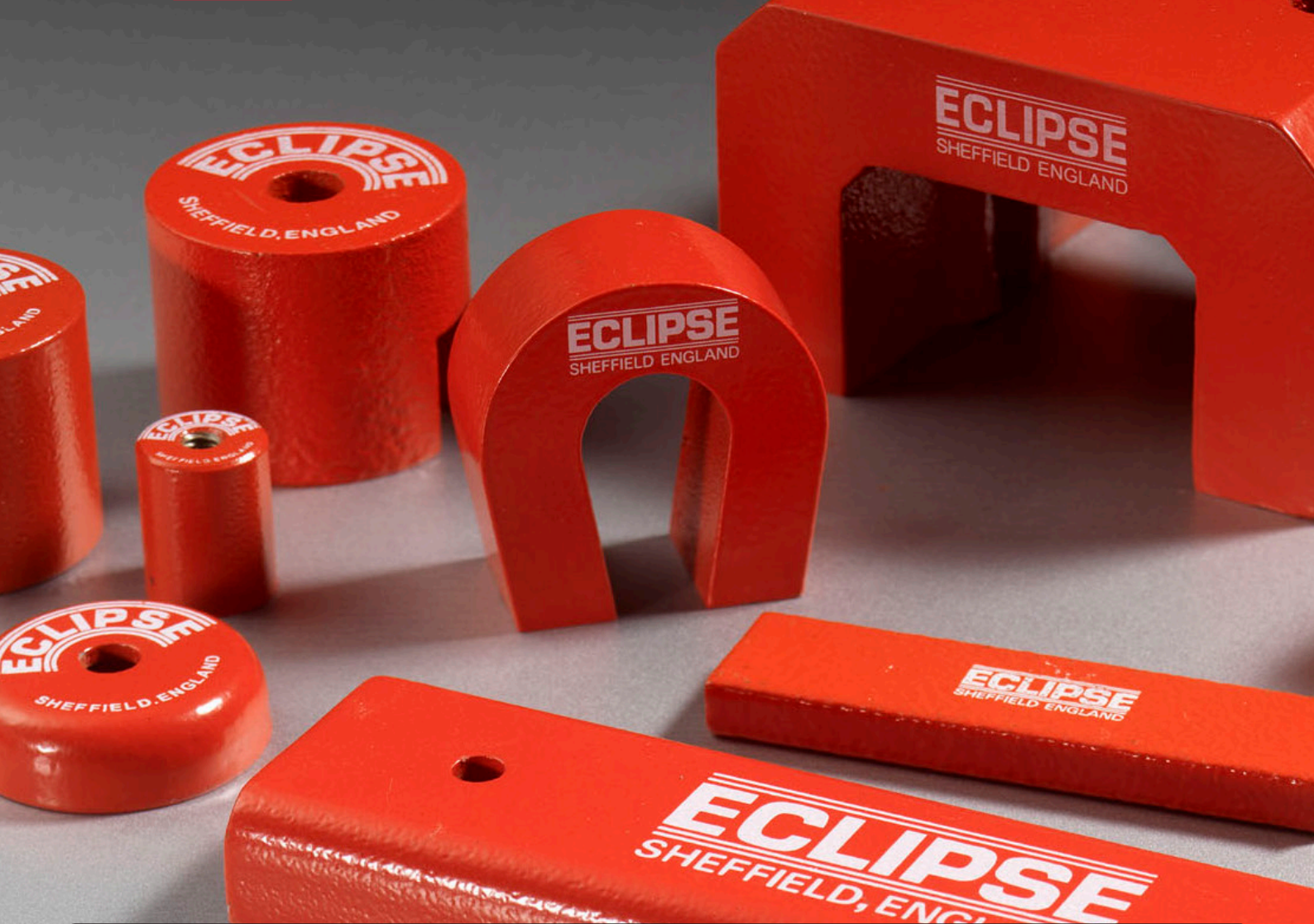

Heritage Range

We have a rich heritage of making magnets since 1914. The "Eclipse Magnetics Red" branding is now a globally recognised brand and an accepted symbol of high-quality craftsmanship and guaranteed high performance.

Over the years, we have set the benchmark for magnet quality, pioneered magnet shapes, colour and sizes which are now the norm worldwide.

Available in a variety of materials and designs for various applications, Heritage Range is a true value adding range for both end-users and stockists.

Typical Applications

The Heritage range is typically used in holding, fixing, clamping and switching applications, including:

- Reed Switches
- Hall Effect Sensors
- Retrieval
- Soldering fixtures
- Positioning jigs
- Circuit boards
- Educational use
- Security Instruments

Heritage

Alnico

(See page 88 for material characteristics)

Alnico Cylindrical Bars

- Sold in pairs
- Typical Applications: Reed switches, hall effect sensors, coin operated machines, security instruments, electrical meters, circuit boards

Product Number	Diameter mm	Length* mm	Weight / Pair g	Gauss	Pairs / Pack
E808**	4	10	2	1200	5
E809**	5	10	3	1200	5
E810**	6	10	4	1200	5
E805	6	20	8	1200	10
E806	8	25	18	1200	5
E807	10	30	35	1200	5



*Magnetic axis
**Supplied natural

Alnico Rectangular Bars

- Sold in pairs
- North pole indicated by notch
- Typical Applications: Components for reed switches, relays, hall effect sensors, oil filters, educational use, laboratory use

Product Number	Material	Length* mm	Width mm	Height mm	Weight / Pair g	Gauss	Pairs / Pack
E842	Alnico 2	50	15	10	220	750	2
E843	Alnico 2	75	15	10	330	750	2
E844	Alnico 5	20	10	5	30	1100	5
E845	Alnico 5	40	12.5	5	40	1100	5
E846	Alnico 5	60	15	5	130	1100	5

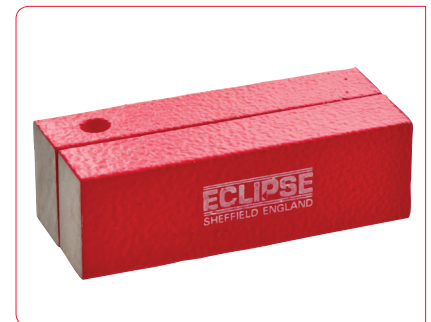

*Magnetic axis

Alnico Minor

- Typical Applications: Educational use, domestic, DIY use, attracting, holding or clamping steel parts

Product Number	Length mm	Width mm	Height mm	Pole Gap mm	Weight g	Pull Force kg	Units / Pack
E801	22.2	7.9	11.1	6.3	10	0.9	10



Alnico



Alnico Buttons

- Typical Applications: Paint plant jigs, damping applications, relay switches, temperature sensitive devices

Product Number	Diameter mm	Height mm	Slot Size (Min–Max) mm	Hole Size mm	Weight g	Pull Force kg	Units / Pack
E821	12.7	9.5	4.0–7.2	4.4	6	0.7	10
E822	19.1	12.7	5.6–8.7	4.8	20	1.9	10
E825	22.2	19.1	6.3–6.3	4.8	50	3	10
E823	25.4	15.9	5.6–8.7	4.8	50	3.4	10
E824	31.8	25.4	8.0–12.7	7.1	113	4.8	2



Alnico Pockets

- Typical Applications: Educational use, domestic /DIY attracting, holding and clamping steel parts

Product Number	Length mm	Width mm	Height mm	Width Of Gap mm	Weight g	Pull Force kg	Units / Pack
E802	28.5	7.6	25.4	6.3	30	2.4	10
E803	33.3	15.9	35	7.9	90	4	5



Alnico Powers

- Typical Applications: Retrieval, welding/soldering fixtures, ultrasonic testing, crack detection, general attracting, clamping and holding steel parts

Product Number	Length mm	Width mm	Height mm	Width Of Gap mm	Hole Size mm	Hole Centres mm	Weight g	Pull Force kg	Units / Pack
811	30	20	20	15	5	n/a	60	4.5	5
812	40	25	25	20	5	n/a	120	9	5
813	45	30	30	23	5	n/a	180	11.8	2
814	57	44.5	35	27.8	2 x 7.9	31.75	370	23.5	1
815	70	57.2	41.3	34.1	2 x 7.9	38.10	710	37	1
816	79.4	82.6	54	38.1	2 x 9.5	42.86	1450	47	1
817	60.3	62	39.7	31.75	n/a	n/a	800	35	1
818	79.4	85.7	54	47.6	n/a	n/a	1800	60	1



Alnico Shallow Pots

- Max operating temperature 450°C
- Mild steel pot
- Typical Applications: For height restricted applications, gripping, lifting, positioning jigs, soldering fixtures, general securing and fixtures

Product Number	Diameter mm	Thickness mm	Hole Size mm	Screw Head Size mm	Weight g	Pull Force kg	Units / Pack
826	19	7.5	4.5	M3 csk	10	3.0	10
827	28.5	8.5	5.2	M4 csk	30	5.0	10
828	38.1	10.35	5.2	M4 csk	80	13.0	5



Alnico Deep Pots

- Max operating temperature 220°C
- Mild steel pot, aluminium spacer
- Typical Applications: Gripping, lifting, positioning jigs, soldering fixtures, general securing and fixtures

Product Number	Diameter mm	Height mm	Thread Size	Weight g	Pull Force kg	Units / Pack
829	9.5	15	M3	5	1	10
830	12.7	15.9	M4	15	2	10
831	17.5	16	M6	23	2.65	10
832	20.5	19	M6	40	4	5
833	27	25	M6	85	6.1	5
834	35	30	M6	184	14.75	2

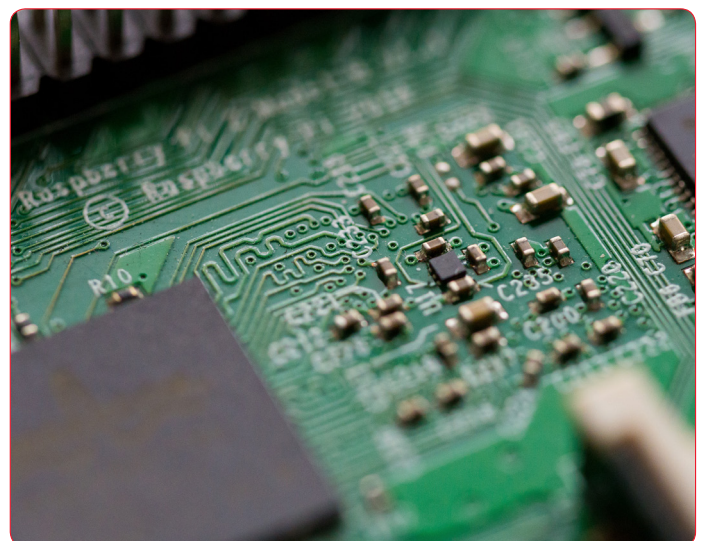

Ferrite

(See page 88 for material characteristics)

Ferrite Shallow Pots With Threaded Hole

- Max operating temperature 120°C
- Mild steel pot
- Typical Applications: For height restricted applications, light lifting, holding, securing and clamping



Product Number	Diameter mm	Thickness mm	Thread	Weight g	Pull Force kg	Units / Pack
E780	50	10	M8	160	15	1
E781	80	18	M10	560	55	1

Ferrite Shallow Pots with Hook

- Max operating temperature 120°C
- Mild steel pot
- Removable hook
- Typical Applications: For height restricted applications, light lifting, holding, securing and clamping

Product Number	Diameter mm	Thickness mm	Thread	Weight g	Pull Force kg	Units / Pack
E890	46	10.7	M6	90	6	5
E891	56	10.7	M6	130	16	5
E892	66	10.7	M6	190	25	5



Product Number	Diameter mm	Height mm	Fixing Stud Centres PCD M6	Central Fixing Point	Weight g	Pull Force kg	Units / Pack
E895	66	10.7	46mm - 3 holes	M6	270	25	1
E896	76	12.5	46mm - 3 holes	M6	300	33	1
E897	100	15.5	70mm - 3 holes	M6	610	55	1



With M6 tapped holes

Heritage

Ferrite

Ferrite Channels

- Max operating temperature 120°C
- Mild steel body
- Ideal for door latches, holding, signage



Product Number	Length mm	Width mm	Height mm	Plain Fixing Holes mm	Hole Centres mm	Weight g	Pull Force kg	Units / Pack
E898/1	115	30	13	4.2	80	250	8	5
E898/2	130	30	13	4.2	90	300	14	5
E899	190	43	13	4.2	110	550	48	2



UTILITY



Utility Range - Work Smart with Magnets

Our Utility Range includes a variety of magnet materials and assemblies which are ideal for design engineering and simple practical applications. From basic clamping or holding to complex power generation or switching applications Utility Range provides a solution.

These high-quality magnets are manufactured to precise tolerances to meet a range of challenges. Whether it's magnetic strength, compact size, lightweight, surface protection, specialist attachments, mountings or temperature resistance, the Utility Range has the answer.

Typical Applications

- Audio system assemblies
- Magnetic pump couplings
- Door catches
- Motors
- Generators
- Sensors
- MRI and NMR
- Magnetic separators
- Magnetic bearings
- Lifting applications
- Retrieval magnets
- POS hanging and attaching

Neodymium

(See page 88 for material characteristics)

Neodymium Discs

- Ideal where compact size and maximum strength are required
- Ideal for retail, display or industrial holding or mounting applications

Product Number	Diameter mm	Thickness* mm	Weight g	Pull Force kg	Units / Pack
N835	3	1	0.1	0.13	50
N800	3	2	0.1	0.3	10
N836	4	1	0.1	0.16	50
N801	4	2	0.2	0.4	10
N802	4	3	0.3	0.7	10
N803	4	4	0.4	0.9	10
N837	5	1	0.2	0.20	50
N804	5	2	0.3	0.55	10
N805	5	3	0.4	0.85	10
N806	5	5	0.7	1.3	10
N838	6	1	0.2	0.33	50
N807	6	3	0.6	1.0	10
N808	6	4	0.8	1.3	10
N824	6	6	1.3	2.00	10
N839	8	1	0.4	0.39	50
N825	8	3	1.2	1.28	10
N809	8	4	1.5	1.7	10
N810	8	5	1.7	2.12	10
N840	9	1	0.5	0.45	50
N811	9	3	1.4	1.6	10
N841	10	1	0.6	0.51	50
N826	10	2	1.2	1.10	10
N812	10	3	1.8	1.65	10
N813	10	5	2.9	2.7	10
N842	12	1	0.9	0.60	50
N827	12	2	1.8	1.30	10
N828	12	3	2.6	2.10	10
N843	15	1	1.4	0.75	50
N814	15	3	4	2.5	3
N829	15	5	6.8	4.10	5
N815	20	3	7.1	3.3	3
N830	20	5	12	5.50	5
N816	20	10	23.6	10.5	1
N831	25	5	19	9.00	5



*Magnetic axis

Neodymium



Adhesive Backed Discs

- Easy application for magnetic closures and fixings
- Material Grade: N42
- Coating Nickel plated
- Adhesive: 3M 468 Adhesive with quick release tab
- Polarity:
 - North - Adhesive on south pole
 - South - Adhesive on north pole



Product Number	Diameter mm	Thickness mm	Polarity	Holding Force kg	Units / Pack	Product Weight Per Pack g
N850N	6	1	North	0.30	50	11.65
N850S	6	1	South	0.30	50	11.65
N851N	8	1	North	0.40	50	18.76
N851S	8	1	South	0.40	50	18.76
N855N	9.5	0.75	North	0.35	50	22
N855S	9.5	0.75	South	0.35	50	22
N852N	10	1	North	0.50	50	30
N852S	10	1	South	0.50	50	30
N853N	12	1	North	0.65	50	41.66
N853S	12	1	South	0.65	50	41.66
N854N	15	1	North	0.80	50	67.5
N854S	15	1	South	0.80	50	67.5

Neodymium Rings

- Ideal for countersunk screw mounting
- For door closures, general fixing and attaching applications

Product Number	Diameter mm	Thickness* mm	Hole mm	Screw Head	Weight g	Pull Force kg	Units / Pack
N832	15.4	3.25	3.3	M3	4.4	3.5	5
N834	17.5	4	4.5	M4	6.9	4.8	5
N833	19	7.6	4.5	M4	15.5	8.1	5
N822	20	10	6 csk	M6	21.4	4.7	1
N823	37	3.5	6 csk	M6	27.5	4.9	1



*Magnetic axis

Neodymium

Neodymium Blocks

- Nickel plated for corrosion resistance
- Ideal for manufacturing, engineering and display projects where compact size and high strength is required

Product Number	Length mm	Width mm	Height* mm	Weight g	Pull Force kg	Units / Pack
N817	25	10	3	5.6	4.7	4
N818	25	10	5	9.4	4.9	4
N819	35	10	5	13.1	5.8	1
N820	50	20	3	22.5	5.8	1
N821	50	50	12.5	243.8	40.1	1



*Magnetic axis

Neodymium Shallow Pots

- High strength clamping and holding performance

Product Number	Diameter mm	Thickness* mm	Weight g	Pull Force kg	Units / Pack
E760NEO	6	4.5	1	0.5	20
E761NEO	8	4.5	1.8	1.3	20
E762NEO	10	4.5	2.5	2.5	20
E763NEO	13	4.5	4.5	6	20
E764NEO	16	4.5	5.5	9.5	20
E765NEO	20	6	15	14	10
E766NEO	25	7	31	20	10
E767NEO	32	7	40	35	10



*Magnetic axis

Neodymium Shallow Pots with Threaded Hole

- Zinc plated body
- With female threaded hole for component mounting

Product Number	Diameter mm	Thickness* mm	Total Height mm	Thread Size mm	Ferrule Outer Dia. mm	Weight g	Pull Force kg	Units / Pack
E770NEO	6	4.5	11.5	M3	6	2.7	0.5	20
E771NEO	8	4.5	11.5	M3	6	3.5	1.3	20
E772NEO	10	4.5	11.5	M3	6	4.5	2.5	20
E773NEO	13	4.5	11.5	M3	6	7.5	6	20
E774NEO	16	4.5	11.5	M4	8	13.2	9.5	20
E775NEO	20	6	13	M4	8	16.5	14	10
E776NEO	25	7	14	M4	8	34	20	10
E777NEO	32	7	15.5	M5	10	48	35	5

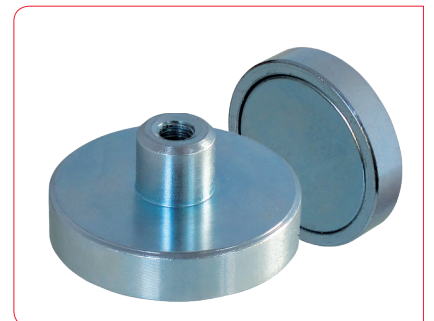

*Magnetic axis

Neodymium



Neodymium Shallow Pots with Countersunk Hole

- Zinc plated body
- With countersunk hole for screw fixings



Product Number	Diameter mm	Thickness* mm	Hole Size mm	Screw Head mm	Weight g	Pull Force kg	Units / Pack
E998/NEO	10	4.5	3	M3	2	1.3	20
E999/NEO	13	4.5	3	M3	3	3	20
E1000/NEO	16	4.5	3.5	M3	6	7.5	20
E1001/NEO	20	6	4.5	M4	13	10.5	10
E1002/NEO	25	7	4.5	M4	24	16	10
E1003/NEO	32	7	5.5	M5	39	31	10
E1004/NEO	40	8	5.5	M5	73	50	5
E1005/NEO	48	11.5	8.5	M8	100	87	1

*Magnetic axis

Neodymium Shallow Pots with Internal Thread

- Zinc plated body with threaded stem
- Maximum operating temperature of 80°C

Product Number	Diameter mm	Thickness* mm	Thread mm	Weight g	Pull Force kg	Units / Pack
E1018/NEO	10	4.5	M3	2.5	1.0	20
E1019/NEO	13	4.5	M3	4.3	2.5	20
E1020/NEO	16	4.5	M4	6.3	5.0	20
E1021/NEO	20	6	M4	11	7.0	10
E1022/NEO	25	7	M5	21	13.5	10
E1023/NEO	32	7	M6	36	25.0	10
E1024/NEO	40	8	M6	68	39.0	5



*Magnetic axis

Neodymium

Neodymium Shallow Pots with Borehole

- Zinc plated body with threaded stem
- Maximum operating temperature of 80°C
- Used in point of sale

Product Number	Diameter mm	Thickness* mm	Hole In Body mm	Hole In Magnet mm	Depth mm	Weight g	Pull Force kg	Units / Pack
E1010/NEO	16	5	3.5	6.5	3.8	9.9	4	20
E1011/NEO	20	7	4.5	8	5.5	13	6	10
E1012/NEO	25	8	5.5	9	6	29.1	14	10
E1013/NEO	32	8	5.5	9	5.5	36	23	10
E1014/NEO	42	9	6.5	11	6	52	32	5



*Magnetic axis

Neodymium Shallow Pots with External Thread

- Zinc plated body with threaded stem
- Maximum operating temperature of 80°C

Product Number	Diameter mm	Thickness* mm	Overall Height mm	Thread mm	Weight g	Pull Force kg	Units / Pack
E1050/NEO	10	4.5	11.5	M3	3.4	2.5	20
E1051/NEO	13	4.5	11.5	M3	3.9	6.0	20
E1052/NEO	16	4.5	13.5	M4	7.1	9.5	20
E1053/NEO	20	6	15.5	M4	14.9	14.0	10
E1054/NEO	25	7	16.5	M5	26.9	20.0	10
E1055/NEO	32	7	18.5	M6	43.9	35.0	5
E1056/NEO	40	8	20	M8	80.1	41.0	5



*Magnetic axis

Neodymium Shallow Pots with Eyelet

- Zinc plated body with threaded stem
- Maximum operating temperature of 80°C

Product Number	Diameter mm	Thickness mm	Overall Height mm	Thread mm	Weight g	Pull Force kg	Units / Pack
E1041/NEO	16	4.5	27.5	M4	9.9	8.0	20
E1042/NEO	20	6	29	M4	13	13.5	10
E1043/NEO	25	7	49	M6	29.1	18.0	10
E1044/NEO	32	7	49	M6	52	30.0	10



Neodymium



Neodymium Bi-Pole Deep Pots with Threaded Hole

- Aluminium pot with mild steel pole pieces



Product Number	Diameter mm	Height mm	Thread Size mm	Weight g	Pull Force kg	Units / Pack
NH025	12.7	12	M5	10	2.5	10
NH065	16	16	M6	18	8.0	10
NH130	22.2	20	M6	40	16.0	5
NH240	25.4	25	M6	70	25.0	5

Neodymium Shallow Pots with Hook

- Zinc plated body with threaded stem
- Maximum operating temperature of 80°C
- Used in point of sale



Product Number	Diameter mm	Thickness mm	Overall Height Inc. Hook mm	Thread mm	Weight g	Pull Force kg	Units / Pack
E1030/NEO	10	4.5	15	M3	4.5	2.5	20
E1031/NEO	13	4.5	15	M3	7.5	6.0	20
E1032/NEO	16	4.5	20.5	M4	13.2	9.5	20
E1033/NEO	20	6	22	M4	16.5	14.0	10
E1034/NEO	25	7	23	M4	34	20.0	10
E1035/NEO	32	7	30	M5	48	35.0	5

Neodymium

Neodymium Shallow Pots with Hook

- Mild steel pot painted white
- For retail and display applications
- Ideal for hanging graphics, utensils, tools etc

Product Number	Diameter mm	Thickness mm	Total Height mm	Weight g	Pull Force kg	Units / Pack
M19863XR	32	7	38	51	35	1



Neodymium Shallow Pots with Swivel Hook

- Turns freely 360° around the magnet base and swing 180°
- Great for hanging various items in a desired direction without the need for nails or screws

Product Number	Diameter mm	Thickness (incl. Ferrule) mm	Height (incl. Hook) mm	Weight g	Pull Force kg	Units / Pack
E1070/NEO	25	15	65	38	18	2
E1071/NEO	32	15	65	52	30	2
E1072/NEO	36	15	65	65	40	2
E1073/NEO	40	15	65	84	50	2



Neodymium Shallow Pots with Spring Closure Carabiner Hook

- Zinc plated body
- 80°c max operating temperature
- Ideal for holding and suspending ropes, wires and cables etc

Product Number	Diameter mm	Height mm	Weight g	Pull Force kg	Units / Pack
E1066/NEO	28	14	30	20	1



Neodymium



Neodymium Bi-Pole Deep Pots

- Brass pot
- Diameter ground to H6 tolerance
- For positioning, holding and clamping

Product Number	Diameter mm	Height mm	Weight g	Pull Force kg	Units / Pack
E750NEO	6	20	4	1.0	20
E751NEO	8	20	7	2.5	20
E752NEO	10	20	11	4.5	20
E753NEO	13	20	19	7.0	20
E754NEO	16	20	29	15.0	10
E755NEO	20	25	57	28.0	5
E756NEO	25	35	128	45.0	2
E757NEO	32	40	228	70.0	2



Neodymium Deep Pots

- N35 grade
- Steel casing

Product Number	Diameter mm	Height mm	Thread Size	Weight g	Pull Force kg	Units / Pack
E740NEO	6	20	M3	4	0.6	20
E741NEO	8	20	M3	7.5	1.2	20
E742NEO	10	20	M4	11	2.4	20
E743NEO	13	20	M4	20	6.0	20
E744NEO	16	20	M4	30	9.0	10
E745NEO	20	25	M6	58	13.5	5
E746NEO	25	35	M6	131	19.0	2
E747NEO	32	40	M8	243	34.0	2



Neodymium Channel Magnet

- High strength magnet for holding, attaching or fixing applications

Product Number	Length mm	Width mm	Height Size mm	Countersunk Hole	Hole Centres	Weight g	Pull Force kg	Units / Pack
NCM010	10	13.5	5	1 x M3	N/A	5	4	5
NCM020	20	13.5	5	1 x M3	N/A	9	8	5
NCM040	40	13.5	5	2 x M3	30	18	17	3
NCM060	60	13.5	5	2 x M3	50	28	30	3
NCM080	80	13.5	5	2 x M3	70	38	35	1
NCM100	100	13.5	5	2 x M3	90	47	37	1
NCM120	120	13.5	5	2 x M3	110	57	42	1



Rubber Covered Neodymium Pots

- Santoprene Rubber coating for scratch-free clamping
- Neodymium Magnets (NdFeB) inside for maximum holding forces
- Extremely good shear forces - high resistance to sliding
- Protects surfaces such as lacquered mild steel car body work
- Maximum recommended operating temperature is 60°C

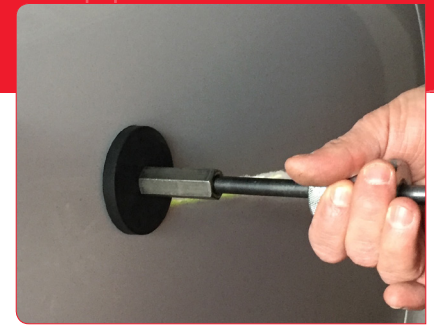

With Threaded Neck

Product Number	Diameter mm	Thickness mm	Overall Height mm	Thread Length mm	Thread Size	Holding Force kg	Units / Pack
E851	22	6	12.5	6.5	M4	5	2
E853	43	6	21	15	M6	8.5	2
E854	66	8.5	23.5	15	M8	18	2
E855	88	8.5	23.5	15	M8	42	2



With Screwed Bush

Product Number	Diameter mm	Thickness mm	Overall Height mm	Bush Diameter mm	Thread Size	Holding Force kg	Units / Pack
E851/1	22	6	11.5	8	M4	5	2
E853/1	43	6	10.5	8	M4	8.5	2
E854/1	66	8.5	15	10	M5	18	2
E855/1	88	8.5	17	12	M8	42	2

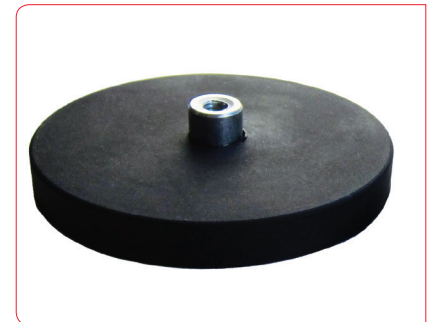

With Internal Thread

Product Number	Diameter mm	Thickness mm	Thread Size	Holding Force kg	Units / Pack
E851/2	22	6	M4	5	2
E853/2	43	6	M4	8.5	2
E854/2	66	8.5	M5	18	2
E855/2	88	8.5	M8	42	2



Rubber Covered Rectangular Neodymium with Internal Thread

Product Number	Length mm	Width mm	Thickness mm	Thread Size	Holding Force kg	Units / Pack
E856/2	43	31	6	1 x M4	8.5	2
E857/2	43	31	6	2 x M4	8.5	2



Alnico

(See page 88 for material characteristics)



Alnico Deep Pots

- Max. operating temperature: 220°C
- Mild steel pot
- Brass spacer
- Zinc plated body

Product Number	Diameter mm	Height mm	Weight g	Pull Force kg	Units / Pack
E790	6	20	4	0.2	20
E791	8	20	7	0.4	20
E792	10	20	11	0.8	20
E793	13	20	19	1.0	20
E794	16	20	29	1.8	10
E795	20	25	57	4.2	5
E796	25	35	140	8.0	2

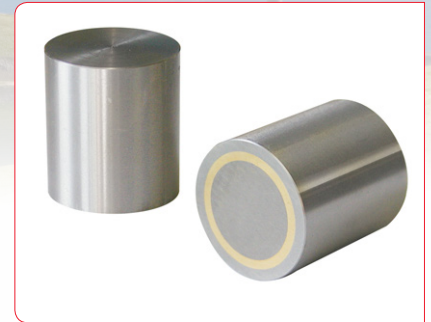

Alnico Deep Pots

- Max. operating temperature: 220°C
- Mild steel pot
- Brass spacer
- Zinc plated body
- Diameter ground to H6 tolerance
- Ideal for press fitting into milled holes

Product Number	Diameter mm	Height mm	Weight g	Pull Force kg	Units / Pack
E730	6	10	2	0.2	20
E731	8	12	4	0.3	20
E732	10	16	9	0.5	20
E733	13	18	17	1.0	20
E734	16	20	29	1.5	10
E735	20	25	57	3.5	5
E736	25	30	110	8.0	5
E737	32	35	200	15.0	2
E738	40	45	420	20.0	2
E739	50	50	720	35.0	1



Utility

Alnico

(See page 88 for material characteristics)

Alnico Deep Pots with Threaded Hole

- Max. operating temperature: 220°C
- Mild steel pot
- Brass spacer
- Zinc plated body

Product Number	Diameter mm	Height mm	Thread mm	Weight g	Pull Force kg	Units / Pack
E740	6	20	M3	4	0.2	20
E741	8	20	M3	7	0.4	20
E742	10	20	M4	11	0.8	20
E743	13	20	M4	19	1.0	20
E744	16	20	M4	29	1.8	10
E745	20	25	M6	55	4.2	5
E746	25	35	M6	250	8.0	5
E747	32	40	M8	370	15.0	2
E748	45	44	M10	500	30.0	2

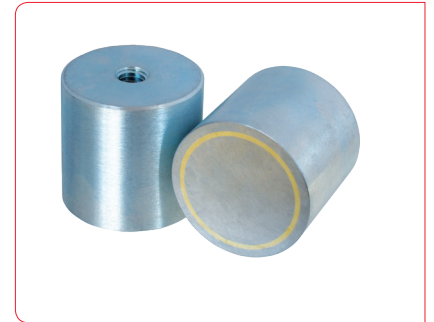

Alnico Major

- Ideal for magnetising small components
- Suitable for wave guidance applications

Product Number	Length mm	Width mm	Height mm	Pole Gap mm	Weight kg	Flux Density at Gap Centre		Units / Pack
						Wb/m	Gauss	
862	103.5	50	111	27.3	2.9	0.210	2000	1



Ferrite

(See page 88 for material characteristics)



Ferrite Shallow Pots with Mounting Hole

- Max. operating temperature: 120°C
- Mild steel pot
- Zinc plated body

Product Number	Diameter mm	Thickness mm	Hole In Body mm	Hole In Magnet mm	Weight g	Pull Force kg	Units / Pack
E888	50	10	8.5	22	9	18	5
E889	80	18	6.5	16	480	54	1

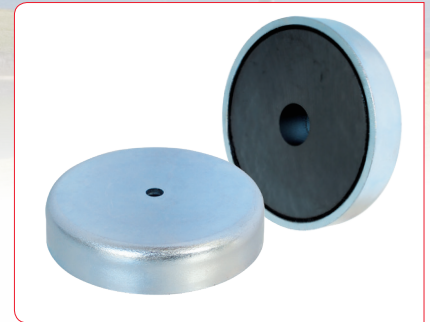

Ferrite Shallow Pots with Countersunk Hole

- For screw fixing

Product Number	Diameter mm	Thickness mm	Hole Size mm	Screw Head	Weight g	Pull Force kg	Units / Pack
E887	20	6	4.2	M4	9	2.7	10
E876	25	7	5.5	M5	16	3.6	10
E877	32	7	5.5	M5	27	7.2	10
E878	40	8	5.5	M5	53	9.0	5

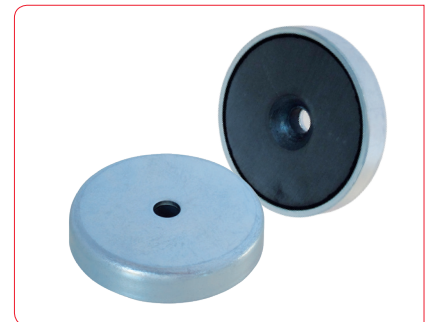

Ferrite Shallow Pots with Male Thread

- Ideal for mounting components

Product Number	Diameter mm	Thickness mm	Overall Height mm	Thread	Weight g	Pull Force kg	Units / Pack
E720	22	7	17	M5	20	3.5	5
E723	32	7	22	M5	32	8.0	5



Ferrite Shallow Pots

- Max. operating temperature: 120°C
- Mild steel pot
- Zinc plated
- For press fit applications

Product Number	Diameter mm	Thickness mm	Weight g	Pull Force kg	Units / Pack
E700	10	4.5	2	0.4	20
E701	13	4.5	3	1.0	20
E702	16	4.5	4.5	1.8	20
E703	20	6	10	3.0	10
E704	25	7	19	4.0	10
E705	32	7	30	8.0	10
E706	40	8	55	12.5	5
E707	50	10	100	22.0	5
E708	63	14	230	35.0	1
E709	80	18	485	60.0	1



Ferrite Shallow Pots with Threaded Hole

- Max. operating temperature: 120°C
- Mild steel pot
- Zinc plated
- Female thread
- Ideal for mounting components with screw or bolt

Product Number	Diameter mm	Thickness mm	Overall Height mm	Thread	Weight g	Pull Force kg	Units / Pack
E860	10	4.5	11	M3	3	0.4	20
E861	13	4.5	11.5	M3	5	1.0	20
E862	16	4.5	11.5	M3	6	1.8	20
E863	20	6	13	M3	11	3.0	10
E864	25	7	15	M4	22	4.0	10
E865	32	7	15	M4	32	8.0	5
E866	36	8	16	M4	45	10.0	5
E867	40	8	18	M5	60	12.5	5
E868	47	9	17	M4	90	18.0	1
E869	50	10	22	M6	110	22.0	1
E870	57	10.5	18.5	M4	145	28.0	1
E871	63	14	30	M8	240	35.0	1
E872	80	18	34	M10	520	60.0	1
E873	90	20	40	M10	820	70.0	1
E874	100	22	42	M12	940	90.0	1
E875	125	26	50	M14	1720	130.0	1



Ferrite



Ferrite Discs

Product Number	Diameter mm	Thickness mm	Weight g	Pull Force kg	Units / Pack
CM700-R	14	5	3.8	0.123	10
CM701-R	20	5	7.9	0.175	10
CM702-R	30	5	17.7	0.262	10



Ferrite Shallow Pots with Hook

- Max. operating temperature: 120°C
- Mild steel pot painted white
- Ideal for retail or general display applications
- For hanging graphics, utensils, tools etc



Product Number	Diameter mm	Thickness mm	Height mm	Thread	Weight g	Pull Force kg	Units / Pack
E879-RB	25	34	8	M4	27	4.0	1
E880-RB	32	34	8	M4	34	8.0	1
E881-RB	36	34	8	M4	38	10.0	1

Ceiling Magnet with Hook

- Simple solution for hanging display materials
- Can be attached/removed quickly with no marking

Product Number	Length mm	Width mm	Height mm	Thread	Weight kg	Pull Force kg	Units / Pack
CM3429	34	29	12	M4	0.04	6	1
CM5715	57	15	24	M4	0.05	11.5	1
CM5327	53	27	12	M4	0.06	15	1

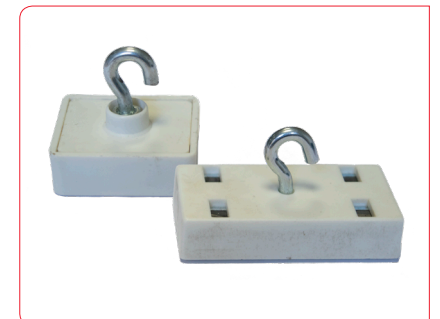

Samarium Cobalt

(See page 88 for material characteristics)

Samarium Cobalt Shallow Pots

- Max. operating temperature: 200°C
- Mild steel pot
- Zinc plated body
- For press fit applications

Product Number	Diameter mm	Thickness mm	Weight g	Pull Force kg	Units / Pack
E760	6	4.5	1	0.5	20
E761	8	4.5	1.5	1.1	20
E762	10	4.5	2.5	2.0	20
E763	13	4.5	4.5	4.0	20
E764	16	4.5	6.5	6.0	20
E765	20	6	15	9.0	10
E766	25	7	22	15.0	10
E767	32	7	40	22.0	10



Samarium Cobalt Shallow Pots with Threaded Hole

- Max. operating temperature: 200°C
- Mild steel pot
- Zinc plated body
- Easy attachment with screw or bolt

Product Number	Diameter mm	Thickness mm	Height (Inc Thread) mm	Thread	Ferrule Outer Dia. mm	Weight g	Pull Force kg	Units / Pack
E770	6	4.5	11.5	M3	6	2.7	0.5	20
E771	8	4.5	11.5	M3	6	3.6	1.1	20
E772	10	4.5	11.5	M3	6	4.5	2.0	20
E773	13	4.5	11.5	M3	6	7.5	4.0	20
E774	16	4.5	11.5	M4	8	9	6.0	20
E775	20	6	13	M4	8	16.5	9.0	10
E776	25	7	14	M4	8	33	15.0	10
E777	32	7	15.5	M5	10	48	22.0	5



Samarium Cobalt



Samarium Cobalt Deep Pots

- Max. operating temperature: 200°C
- Brass pot
- Diameter ground to H6 tolerance
- Ideal for press fit installation



Product Number	Diameter mm	Thickness mm	Weight g	Pull Force kg	Units / Pack
E750	6	20	4	0.8	20
E751	8	20	7	2.2	20
E752	10	20	11	4.0	20
E753	13	20	19	6.0	20
E754	16	20	29	12.5	10
E755	20	25	57	23.0	5
E756	25	35	128	40.0	2
E757	32	40	228	60.0	2



Did you know?

"A typical car can contain 120 magnet assemblies"



ELECTRO



Electromagnets - Work Smart with Magnets

Our high-performance range of electromagnets are widely used for a variety of design engineering projects e.g. access control systems, medical devices and automation systems.

The standard electromagnet concept - a solenoid (wound copper coil) within a high-quality high permeability iron assembly - gives high clamping forces with low magnetic losses. They offer cost effective, energy efficient, durable solutions for manual and automated hold and release applications.

Typical Applications

- Door locks
- Alarm systems
- Security devices
- Card readers
- Sensors
- Actuators
- MRI scanners
- Stage Design
- Robotics
- Vending machines
- Audio systems

Electromagnets

Energise to Hold

Power required to turn magnet ON. Power removed to turn magnet OFF.

- Sturdy bright nickel plated cylinder, passivated with body mounting
- High-quality permeable iron for low remanence
- Armature plates to suit

Operating Voltage 12VDC, 24VDC & 240VAC (with rectified plug connector)
Connector Options Flying leads, two-pole connector and Hirschman connector
Mounting Threaded holes in magnet rear face
Finish Bright nickel plated with machined face
ED Rating 100%
IP Rating 54 (20 for the two-pole connector)



Standard Operating Voltage							Air Gap mm												
240VAC Product Number		Current mA	24VDC Product Number		Current mA	12VDC Product Number		Current mA	0	0.09	0.18	0.27	0.36	0.59	1.00	1.59	2.00	4.00	
							Pull Force (+/- 10%) Newtons												
Diameter mm	20		M52180/24VDC	100	M52180/12VDC	210	53	22	9	5	3	2	1	-	-	-			
	25		M52172/24VDC	90	M52172/12VDC	180	150	51	22	12	8	4	2	-	-	-			
	30		M52173/24VDC	140	M52173/12VDC	280	280	149	80	43	26	12	5	2	2	-			
	40		M52174/24VDC	230	M52174/12VDC	440	550	276	144	83	57	30	14	7	5	3			
	50	M52175/240VA	40	M52175/24VDC	240	M52175/12VDC	470	1000	655	442	282	187	87	37	24	19	6		
	65	M52176/240VA	50	M52176/24VDC	340	M52176/12VDC	690	1670	1137	792	533	347	180	78	39	23	11		
	80			M52183/24VDC	580	M52183/12VDC	1116	2000	1560	1117	715	567	283	130	67	37	20		
100			M52184/24VDC	940	M52184/12VDC	1850	3600	2790	2230	1610	1360	1340	470	260	150	60			

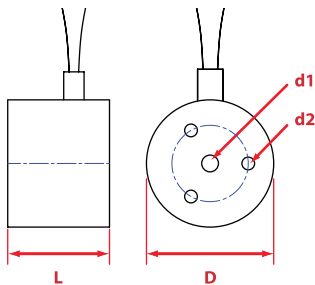

20, 25, 30mm diameter. Free leads (500mm long)
 Leads: 1 red, 1 black. 0.3mm square x 500mm long)

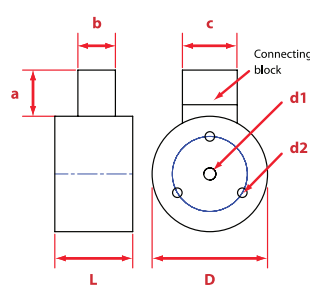

40, 50, 65, 80, 100mm diameter.
 12VDC & 24VDC. Two pole connector

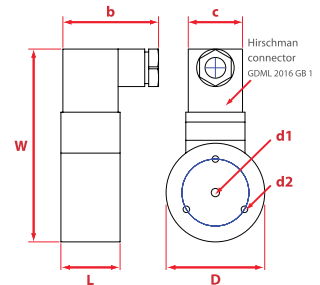

50, 65mm diameter 240VAC.
 Hirschman Connector

Product Number	Dimension mm								PCD mm	Weight g
	D	L	W	A	B	C	D1	D2		
12 & 24V Units										
M52180/24VDC	20	18	-	-	-	-	M4	M3	14	36
M52172/24VDC	25	20	-	-	-	-	M4	M3	15	66
M52173/24VDC	30	24	-	-	-	-	M5	M3	18	108
M52174/24VDC	40	27	-	16	13	19	M5	M4	26	210
M52175/24VDC	50	30	-	16	13	19	M5	M4	34	364
M52176/24VDC	65	35	-	16	13	19	M8	M5	40	710
M52183/24VDC	80	38	-	16	13	19	M8	M6	50	1203
M52184/24VDC	100	43	-	16	13	19	M10	M6	75	2200
240V Units										
M52175/240VA	50	30	98	-	50	30	M5	M4	34	408
M52176/240VA	65	35	111	-	50	30	M8	M5	40	744



ELECTRO

Energise to Release

Power required to turn magnet OFF. Power removed to turn magnet ON.

- Sturdy bright nickel plated cylinder, passivated with body mounting
- High-quality permeable iron for low remanence
- Armature plates to suit

Operating Voltage	24VDC & 240VAC (with rectified plug connector)
Connector Options	Hirschman connector
Mounting	Central machined hole in rear face of magnet
Finish	Bright nickel plated with machined face
IP Rating	S4
Duty Cycle	S2



		Standard Operating Voltage				Air Gap mm							
		240VAC Product Number	Current mA	24VDC Product Number	Current mA	0	0.09	0.18	0.27	0.36	0.59	1.00	1.59
		Pull Force (+/- 10%) Newtons											
Diameter mm	35	M52177/240VA	50	M52177/24VDC	240	250	91	51	32	23	17	–	–
	50	M52178/240VA	40	M52178/24VDC	350	500	317	208	151	116	73	47	28

Product Number	Dimensions mm						Weight g
	D	L	B	W	Connector	D1	
M52177/24VDC	35	48	50	78	Hirschman Style	M5	352
M52178/24VDC	50	63	50	94	Hirschman Style	M5	874
M52177/240VA	35	48	50	81	Hirschman	M5	354
M52178/240VA	50	63	50	97	Hirschman	M5	880

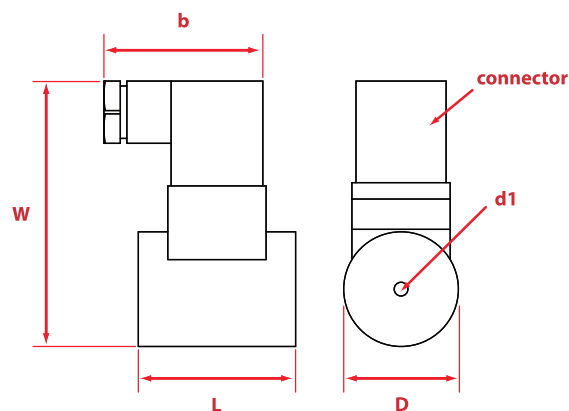

Armature Plates

- To fit both types

Product Number	Diameter mm	Height mm	Screw	To Suit Diameter mm	Weight g
M52171/25ARM	25	3	M3	20.25	15
M52171/30ARM	30	4	M4	30	30
M52171/40ARM	40	5	M4	35 / 40	50
M52171/50ARM	50	6	M4	50	100
M52171/65ARM	65	8	M5	65	210
M52171/80ARM	80	10	M6	80	400
M52171/100ARM	100	12	M10	100	740



To achieve the optimum pull force, 100% contact area must be achieved using the recommended armature plate. The force will be affected if other material specifications, thickness and surfaces are used, or if the armature fails to make positive contact over the full diameter of the face of the magnet. Where misalignment is likely to be an issue we recommend that an oversized armature plate is used to ensure 100% full contact, this however will reduce the stated pull force by approximately 10%



Did you know?

"With a magnetic North & South Pole
the Earth is like one big bar magnet"



LIFTING

Work Smart & Safely with Magnetic Lifting

Our lifting and handling systems are based on fail-safe magnetic technology which drives process efficiency and optimum operation safety. Ideal for a range of lifting applications from heavy duty steel-stock movement to light duty pick and place, magnetic lifting is the most efficient way of moving ferrous loads.

Total Safety

Operation safety is the foremost consideration in the design of all our magnetic lifting and handling systems. Each model has built-in safety mechanisms and comply with HSE guidelines such as the Lifting Operations and Lifting Equipment Regulations (LOLER) and the Provision and Use of Work Equipment Regulations (PUWER). They are also designed in accordance with ASME B530.20-2010

Offers major benefits over slings, chains, hooks and grabs:

- Simple, Easy to use – ready to use in minutes
- Increased lifts per hour – simple on-off, single face engagement with load
- Protects the load – minimal surface contact, no sliding or movement
- Single person operation – labour efficient, minimal training required
- Optimised space – access only required to one face of the load
- Precision – greater lifting control/placement



UltraLift^{plus}+

3 Safety Features

- Locking switch handle mechanism
- Unique 'Safety Shim' - Pre-test any load to ensure a 3:1 safety factor
- Locking eye mechanism
 - Magnet cannot be switched off while holding a load

Magnetic lifters are quicker, easier and safer to use than slings, chains, hooks and grabs, and do not mark the load.

Onboard switching and permanent magnet technology mean installation and operation could not be easier and running costs are non-existent. Access is only required to the load's top face, allowing for more efficient storage and handling.

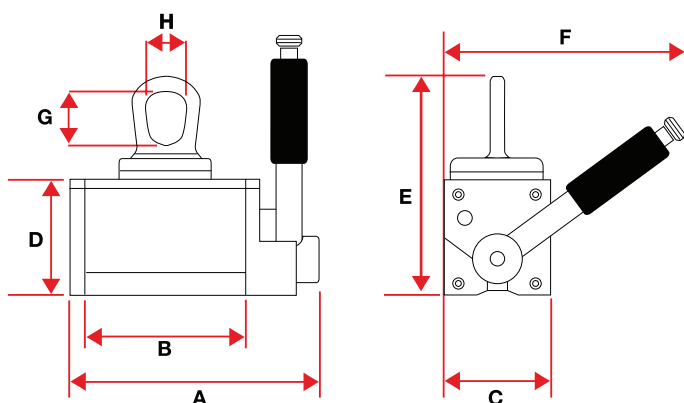

3:1 Safety Factor

The patented 'safety shim' allows pre-testing of the load to be lifted irrespective of weight, material, thickness and surface condition.



Product Number	Self Weight kg	Dimensions mm								Material Length Max. mm	Flat Section		Round Section	
		A	B	C	D	E	F	G	H		SWL* kg	Thickness Min. mm	SWL* kg	Diameter Max mm
UL0125+	4	155	101	69	74	138	152	34	27	1500	125	20	50	200
UL0250+	11	214	155	92	96	192	218	51	40	1500	250	25	100	300
UL0500+	27	300	224	122	128	251	266	63	49	2000	500	30	200	400
UL1000+	63	359	260	176	174	314	382	71	55	3000	1000	45	400	450
UL2000+	157	477	368	233	227	422	552	102	79	3000	2000	55	800	600

*Safe working load

UltraLift



UltraLift LM

- Lifts up to 2000kg (flat) 800kg (round)
- Locking switch handle safety mechanism

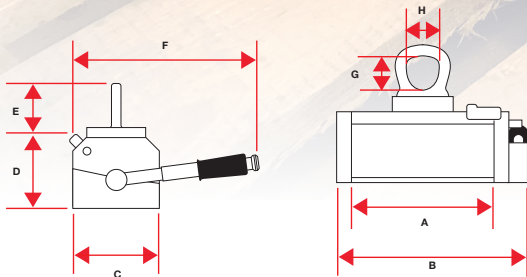

Product Number	Self Weight kg	Dimensions mm								Material Length Max mm	Flat Section		Round Section	
		A	B	C	D	E	F	G	H		SWL* kg	Thickness Min. mm	SWL* kg	Diameter Max mm
LM0125	4.5	150	110	76	62	120	150	30	27	1500	125	20	50	250
LM0250	8.5	210	165	90	72	150	200	45	40	1500	250	25	100	300
LM0500	17.5	281	225	106	88	191	243	53	48	2000	500	30	200	400
LM1000	36.5	391	325	136	103	217	365	59	52	3000	1000	45	400	450
LM2000	79	483	400	186	132	302	526	88	79	3000	2000	70	800	600

*Safe working load

UltraLift TP

Thin Plate Lifter

- Lifts up to 400kg (flat)
- Specifically designed for the safe lifting of thin plate and pressings
- Can lift single sheets from the tops of stacks
- Locking switch handle safety mechanism

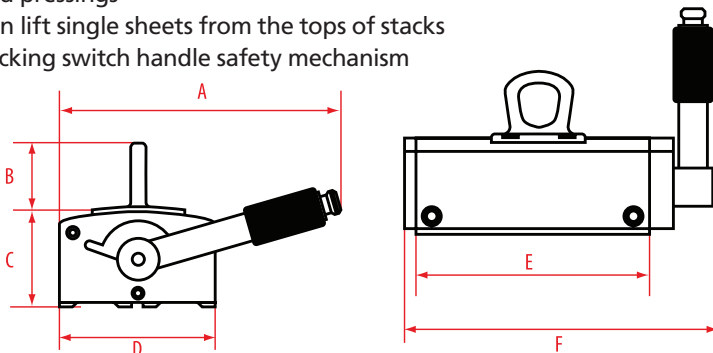

Product Number	Self Weight kg	Dimensions mm							Material Thickness mm							
		A	B	C	D	E	F	SWL* kg	Length mm	SWL* kg	Length mm	SWL* kg	Length mm	SWL* kg	Length mm	
TP150	8	181	52	74	100	150	202	75	1500	100	1500	150	1500	200	1500	
TP300	15	181	52	74	100	300	352	150	2000	200	2000	300	2000	400	2000	

*Safe working load

Lifting

Lifting

90° Disc and Plate Lifter

- Cost effective lifting frame with permanent lifting magnet
- Ideal for lifting and rotating steel discs and plates in positioning and machine loading applications
- Full adjustment and built in safety features



How it works

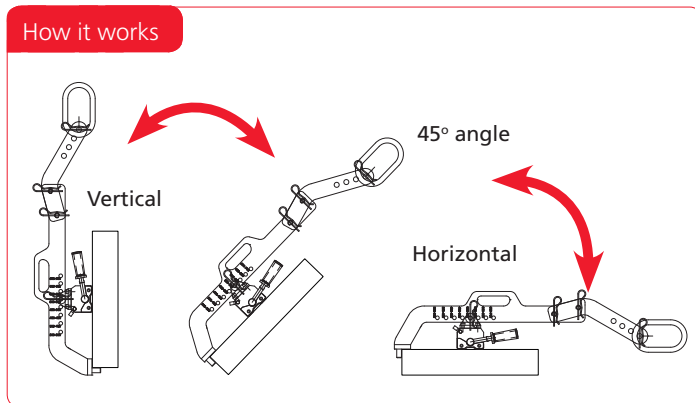

90° lifter can lift round and rectangular items.

Product Number	SWL* kg	Load Thickness Min. mm	Load Thickness Max. mm	Load Diameter Min. mm	Load Diameter Max. mm
LF125	125	20	55	250	600
LF250	250	30	80	300	700
LF500	500	40	125	350	800
LF1000	1000	50	160	500	1000



*Safe working load

Handling

Electronically switchable permanent magnet (ESPM)



Optimag E

- Ideal for clamping or lifting loads with clean, even, flat surfaces
- Suitable for applications which require sensing or built-in PLC control
- Failsafe operation - lose power it will retain the hold
- Ideal for materials from 10mm thick

Product Number	Load Profile	SWL* kg	Dimensions mm				Unit Weight kg	Rating @ 240v
			A	B	C	D		
Circular								
ESPM80C	Flat	85	80	55	N/A	N/A	1.5	3.1
ESPM100C	Flat	150	105	55	N/A	N/A	3	4.4
ESPM125C	Flat	250	130	80	N/A	N/A	5.7	9.2
ESPM150C	Flat	400	155	80	N/A	N/A	8	11.5
Rectangular**								
ESPM284	Flat	42	N/A	83	40	80	1.4	2.8
ESPM286	Flat	49	N/A	83	60	80	1.9	5.6
ESPM2166	Flat	97	N/A	83	60	160	3.8	11.4
ESPM2246	Flat	146	N/A	83	60	240	5.9	14.3
ESPM2177H	Flat	300	N/A	130	75	170	11	10
ESPM2257H	Flat	450	N/A	130	75	250	16.5	16
ESPM2347H	Flat	600	N/A	130	75	340	22	20

*Safe working load

**Can be manufactured to lift flat or round

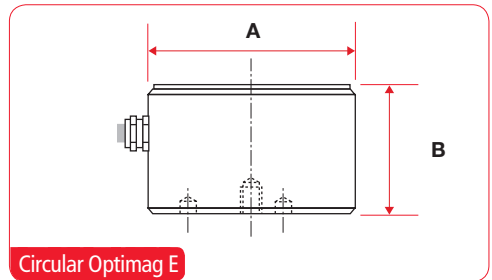

Circular Optimag E

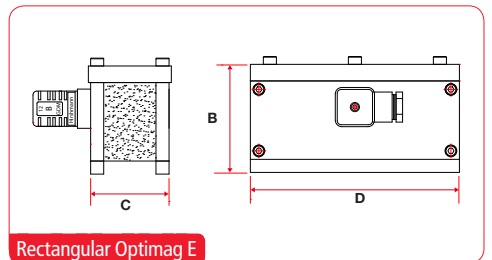

Rectangular Optimag E

ESPM Controller Unit

Product Number	Operating Voltage	Rating	Dimensions mm		
	v		Width	Height	Depth
M24388/SC	240	50	300	300	155
M24388/DC	240	100	300	300	155
6001CONT	415	180	400	300	155
M24388/HAND	N/A	N/A	112	65	55
6001/MH	N/A	N/A	112	65	55



ESPM Control Unit

Lifting

Handling

Pneumatically switchable permanent magnet (PSPM)

Optimag P

- Ideal for rigid, thin or perforated pressings or sheet
- Suitable for loads with rough, uneven or painted surfaces
- Failsafe operation - lose air clamping hold is retained
- Ideal for material thicknesses from 2mm thick

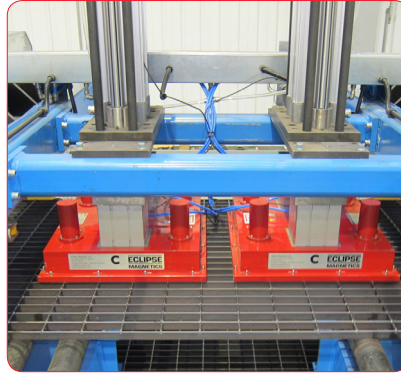

Product Number	Load Profile	SWL* kg	Dimensions mm				Unit Weight kg
			Diameter A	Height B	Width C	Length D	
Circular							
PSPM80C	Flat	8.5	80	78.5	N/A	N/A	1.00
PSPM100C	Flat	18.5	100	82.5	N/A	N/A	1.50
PSPM125C	Flat	29	125	93	N/A	N/A	3.00
PSPM150C	Flat	59	150	109	N/A	N/A	4.80
Rectangular							
PSPM1520	Flat	35	N/A	165	200	150	6.00
PSPM2030	Flat	100	N/A	201	300	200	14.70

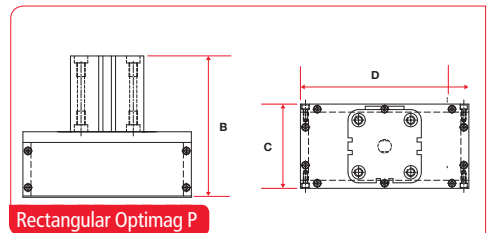
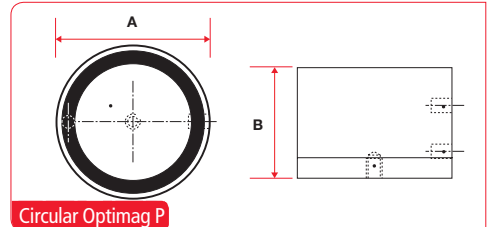

*Safe working load

Testing Service & Spares

We test and repair all models of permanent magnetic chucks, lifters and magnetic tools.

- Free inspection and quotation
- Certificate of performance for magnetic lifters to satisfy H&S audits
- Spare parts available

For more details, call us on +44 (0)114 225 0600





WORKSHOP

Workshop Tools – Work Smart with Magnets

Our Workshop range definitely allows you to "Work Smart with Magnets". We have applied our magnetic expertise to produce a range of magnetic tools which overcome simple everyday challenges faced in engineering workshops, factories, commercial workplaces and public spaces.

Typical Applications

- Tool storage
- Lost item retrieval e.g. keys or tools
- Car park clearing
- Swarf skimming
- Work bench cleaning
- Holding nails, screws, bolts
- Garage retrieval
- Sheet separation
- Demagnetisation
- Magnet fishing
- Protecting sports fields, play areas

Retrieval

Light Duty Telescopic Magnetic Retrieval Tool

- High precision Magnetic Retrieval tool
- Ideal for precise pick-up and retrieval
- Compact size with added pocket clip
- Extends 66cm
- Extra wide versions available for large areas

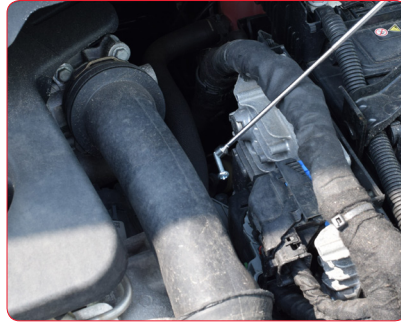

Product Number	Length mm	Weight kg	Pull Force kg
EM967-R	147-660	0.04	1

Heavy Duty Telescopic Magnetic Retrieval Tool

- Telescopic Magnetic Retrieval tool with over 7kg pick up capacity
- Extends to 77cm
- Anti-slip rubber handle for use in any working environment



Product Number	Length mm	Weight kg	Pull Force kg
MRT770	180-770	0.88	7

Retrieval

WORKSHOP

Heavy Duty Telescopic Magnetic Retrieval Tool with Torch

- Extends to 81cm with 3kg magnetic hold
- Perfect for retrieving objects in hard to reach places
- Powerful LED Light (batteries Included)



Product Number	Length mm	Weight kg	Pull Force kg
MRT810T	190-810	0.08	3

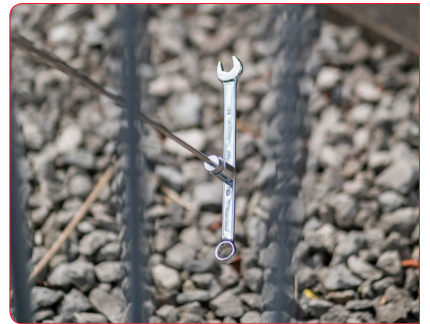

Multifunction Telescopic Magnetic Retrieval Tool with Torch and Inspection Mirror

- Multi Function Telescopic Magnetic Retrieval tool with LED and inspection mirror
- Flexible head ideal for hard to reach places
- With added magnetic base can be used as inspection light
- Inspection mirror ideal in confined spaces
- Powerful LED Light (batteries Included)

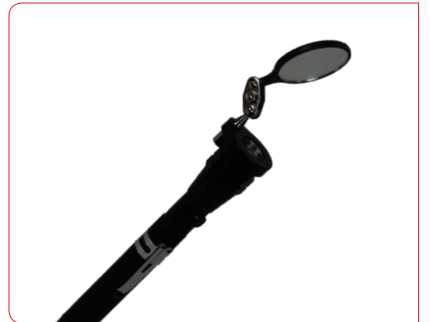

Product Number	Length mm	Weight kg	Pull Force (Head) kg	Pull Force (Base) kg
MRT582MF	175-582	0.132	3.5	5.0

Retrieval

Flexible Magnetic Retrieval Tool

- Flexible Magnetic Retrieval
- Ideal for retrieving items in hard to reach places
- Available up to 52cm



Product Number	Length mm	Weight kg	Pull Force kg
E601	450	0.12	1.0
E602	520	0.13	1.8

Product Number	Length mm	Magnet Diameter mm	Outer Diameter mm	Weight kg	Pull Force kg
MRT505F	505	6	6.5	0.10	0.9

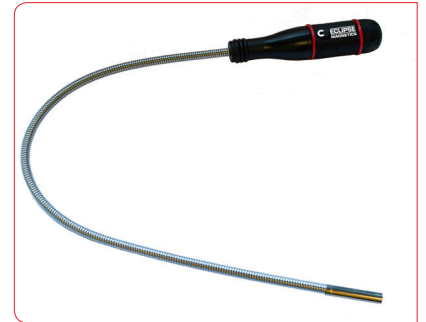

Special Magnetic Retrieval Tool with Torch and Claw

- 62cm flexible length ideal for hard to reach places
- Push button spring steel retrieval claw ideal for non-magnetic pickup
- Powerful LED Light (batteries Included)



Product Number	Length mm	Weight kg	Pull Force kg
MRT625MFF	625	0.15	2.25



Retrieval



Recovery Tool

- Constructed from a ferrite magnet sandwiched between two steel plates
- Designed for recovery or retrieval, such as recovering objects from coolant tanks or vats

Product Number	Width mm	Height mm	Thickness mm	Weight kg	Pull Force kg
E936	80	101.5	36	1.4	50



Magnetic Sweepers

- Attracts potentially dangerous or damaging ferrous items e.g. nails, pins, staples
- For easy clear of work areas, floors, sports pitches or car parks
- With adjustable telescopic handle
- Handle mounted quick release mechanism releases debris collected
- Extra wide version available for large areas



Product Number	Head Width mm	Height Including Handle mm	Weight kg	Pull Force kg
MSW385	385	1050	1.225	2
MSW620	620	1050	1.925	8
MSW940	940	1050	2.695	12

Forklift Mounted Magnetic Sweeper

- Used for clearing larger areas e.g. factory floors, car parks of steel debris
- Reduces the risk of expensive punctures or human injury
- Easily mounted onto forklifts and secured with fastenings
- Corrosion resistant
- Incorporates a "quick release" mechanism for easy cleaning



Product Number	Overall Length mm	Width mm	Height (Box Section) Overall Height (Excl.Eyebolt) mm	Depth of Field mm	Weight kg	Pull Force kg
MSW1200/FLT	1200	76	100/148	60	14	90

Magnetic Rake

- Protects grassed areas, sand, gravel, soil from potentially dangerous ferrous items
- Robust construction
- Telescopic handle
- Quick release mechanism of magnet



Product Number	Head Width mm	Length mm	Weight kg
MR305	305	1100	0.835

Pick-Up

WORKSHOP

Magnetic Pick-Up Wand

- Quick and safe pick-up of iron and steel offcuts, filings, chips and general swarf
- Features a quick release handle
- Lightweight and extremely durable - non-rusting
- Long reach version available 90cm



Product Number	Length mm	Weight kg	Collection Capacity kg
MW400	400	0.476	6.35
MW900	900	0.725	6.35

Magnetic Pick-Up Tool

- Long reach pick-up tool
- Large magnetic head
- Ideal for garage, workshop factory, general purpose use
- Telescopic handle
- Holds up to 4kg



Product Number	Head Diameter mm	Length mm	Weight kg	Pull Force kg
MPT1100	88	990	0.835	4

Magnetic Hand Lifter

- Quick and easy pick-up of ferrous components, plates and discs
- Easy attachment to/release from ferrous surfaces
- Features a comfortable non-slip rubber grip
- Separates awkward to handle/pick up items



Product Number	Length mm	Width mm	Height mm	Weight kg	Pull Force kg
MHL	130	28	85	0.42	45

Pick-Up

Hand-Held Pick-Up Tool

- Ferrite magnet attracts ferrous items to base
- Quick release handle frees attracted items
- Ideal for picking up small components, nails, bolts and spilt materials

Product Number	Length mm	Width mm	Height mm	Weight kg	Pull Force kg
E961	121	41	235	2.75	1.15



Heavy Duty Hand-held Magnetic Pick-Up Tool

- Powerful ferrite magnet for easy pick-up and release of ferrous items
- Features a quick release handle to free attracted items
- An effective, rapid means of lifting small iron and steel parts from stock bins, boxes
- Long reach handle version available (see below)



Product Number	Length mm	Width mm	Height mm	Weight kg	Pull Force kg
MPT185	120	70	185	1.130	6

Long Reach Heavy Duty Hand-Held Magnetic Pick-Up Tool

- Facilitates easy pick up and placement of items from ground level locations
- User friendly, safe, practical and time saving
- Features a quick release handle to release attracted items

Product Number	Length mm	Width mm	Height mm	Weight kg	Pull Force kg
MPT700	120	70	700	2.030	6



Workshop Tools

WORKSHOP

Magnetic Tool Rack

- Contains 2 powerful magnetic bars with extruded magnetic rubber lengths, housed between two pole pieces
- Neatly secures and holds tools in the garage or workshop and knives in the kitchen

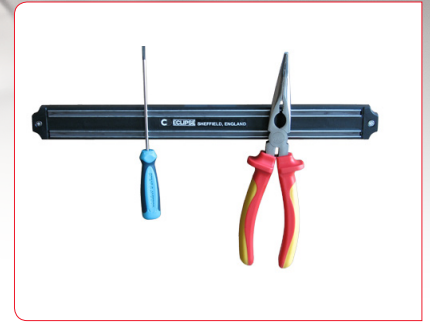

Product Number	Length mm	Height mm	Thickness mm	Weight kg
EM985-R	350	33	13	0.31

Heavy Duty Magnetic Tool Rack

- An efficient way of keeping your most-used tools organised, visible and accessible
- Ideal for use in the home, garage or workshop
- Modular design allows multiple units to be connected
- Easily mount screwdrivers, hammers, wrenches, spanners, ratchets, pliers, saw blades, knives, scissors etc
- Non-magnetic tools can be placed between the rack and the wall
- Simple screw-fit attachment to wall or other surfaces



Product Number	Overall Length mm	Body Width mm	Body Depth mm	Weight kg
MTR250	345	24.5	14	0.480
MTR400	506	24.5	14	0.730



Mobile Magnetic Tool Rack

- Simple and neat way to store tools in multi-locations
- Magnetic both sides for simple attachment to tool cabinets or other steel surfaces.
- Can be used to carry tools between locations

Product Number	Overall Length mm	Body Width mm	Body Depth mm	Weight kg
MTR250M	305	50	14	0.570

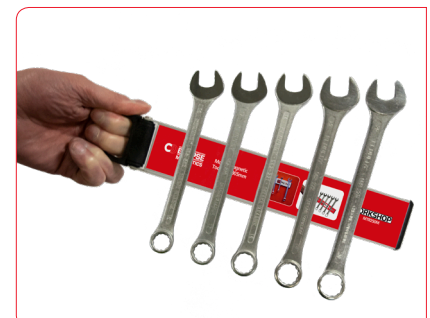

Workshop Tools

Magnetic Trays

- Perfect for secure holding small metal parts and tools
- Magnetic both sides - can be used horizontally, vertically or even upside down
- Features rubber scratch guard to protect location surface
- Suitable for automotive mechanics, limited access repairs and general workshop
- Premium quality stainless steel finish
- Several size options available (see below)

Magnetic Trays Round

Product Number	Diameter mm	Overall Height mm	Bowl Depth mm	Weight kg
E634 (MT100)*	107	32	19	0.160
E633 (MT150)*	150	36	22	0.290



*New product code coming soon

Magnetic Trays Rectangular

Product Number	Length mm	Width mm	Overall Height mm	Bowl Depth mm	Weight kg
MT2414	237	136	42	28	0.600
MT3616	358	160	38	23	0.930



Magnetic Tray Square

Product Number	Length mm	Width mm	Overall Height mm	Bowl Depth mm	Weight kg
MT2927	292	270	38	26	1.250



Workshop Tools

WORKSHOP

Magnetic Wristband

- Effectively provides you a "third hand"
- Great for storing small tools and screws while you work
- Adjustable strap allows a one size fits all
- Includes 10 strong magnets perfect for holding screws, nails, drill bits and other tools



Product Number	Overall Length mm	Width mm	Weight kg
MWB157	330	90	0.070

Magnetiser / Demagnetiser

- A great addition to every toolbox!
- A convenient pocket-sized tool & housed in a strong plastic case
- Ideal for magnetising/demagnetising of small hand tools i.e. screwdrivers, hexagon keys etc
- EASY TO USE! Magnetises and demagnetises in seconds
- Demagnetises screwdriver tips prior to work on sensitive electronic components
- Corrosion-resistant with protective polymer shell
- 2 sizes available



MDT050



MDW100

Product Number	Description	Length mm	Width mm	Depth mm	Weight kg
MDT050	Magnetiser / Demagnetiser - Toolbox	52	50	29	0.070
MDW100	Magnetiser / Demagnetiser - Workshop	98	98	41	0.260

Magnetic Vice Jaws

- Powerful neodymium magnet material encased in polyurethane
- Secure round and irregular workpieces without damage or distortion

Product Number	Length mm	Height mm	Width mm	Weight Per Pair kg
EM983-R	103	32	31	0.13



Workshop Tools

Magnetic Vice Jaws

- Rubber magnetic jaws securely holds your workpiece without damaging or marking surface
- Ideal for jewellery makers, gripping objects, holding wood, metals and tubing

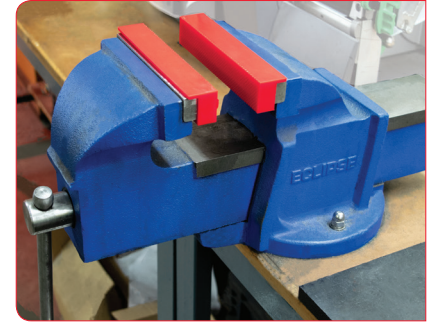
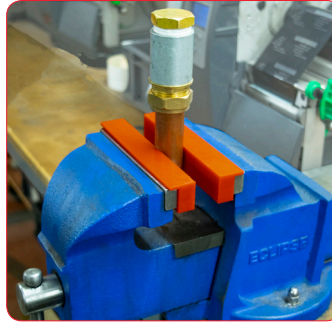

Product Number	Length mm	Width mm	Height mm	Weight kg
MVJ/4	113	25	28	0.14
MVJ/6	156	25	28	0.18

Sheet Floaters

- Sheet separators use magnetic repulsion to separate sheets in a stack so they can be removed more easily
- Sold in pairs

Product Number	Width mm	Height mm	Depth mm	Mounting Hole Size	Weight Per Pair kg
E913	73	76	65	M8	1.40
E914	92	102	76	M8	3.10
E915	113	152	89	M10	6.75

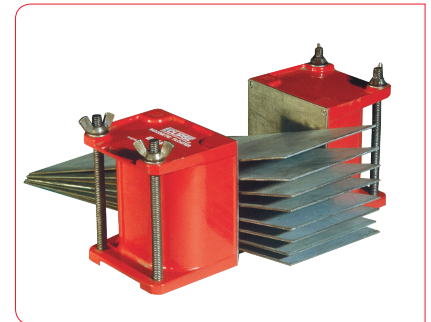

Holding Magnet with Eyelet

- Designed to retrieve and hold flat steel surfaces, nails, hand tools and other ferrous items on contact
- Magnet assembly made of ceramic (ferrite) magnets and steel enclosed with durable red plastic and black rubber
- Eyebolt can be added on the top or side of magnet and used to hold, lift and hang objects



Product Number	Length mm	Width mm	Overall Height (Excluding Bolt) mm	Weight kg	Pull Force kg
HM6460	64	60	32	0.34	45

Table-top Demagnetiser

- Lightweight unit for the removal of residual magnetism from components after workholding
- CE Approved
- Max Usage: 2 mins in any 4 minute period



Product Number	Voltage mm	Width mm	Height mm	Depth mm	Weight kg
DA955/UK	240	150	117	87	3.83
DA955/EUR	220	150	117	87	3.83
DB956/EUR	110	150	117	87	3.83

Pole Indicator

- Shows the true north or true south pole of magnets
- Pocket sized
- Battery powered - Includes 4 x 1.5v batteries



Product Number	Length mm	Width mm	Thickness mm	Weight kg
MPI/100	132	22	19	0.11

Gauss Meter

- Digital hand held Gauss meter for checking magnetic flux
- GMET/1 Supplied with 1 Transverse Probe (TX), Case and battery (PP3)
- GMET/2 Supplied with 2 Transverse Probes (TX), Case and battery (PP3)
- Axial Probe available upon request
- Measurement units: Gauss, Tesla, Oersteds, Ampere meters



Measuring Range Settings

- 1 - 1 to 3000 Gauss (0.0001 to 0.3 Tesla) Resolution - 1 Gauss
- 2 - 10 to 30,000 Gauss (0.001 to 3 Tesla) Resolution - 10 Gauss
- Auto: Automatically measures between settings 1 and 2
- +/- 15mT on/off hysteresis

Product Number	Weight kg
GMET/1	0.5
GMET/2	0.5

Mounting/Measurement

Flexible Inspection Lamp

- Switchable lamp with magnifying glass for close inspection or intricate, detailed work
- Ideal for use in quality inspection, model making, precision finishing
- 10 x magnification factor allows you to work with confidence
- Features flexible support arm for adjusting angle/direction
- Can be supplied with or without compatible Magnetic Bases



Inspection Lamp

Product Number	Metal Tube mm	Head Diameter mm	Glass Lens Diameter mm	Cable Length mm	Screw Thread mm	Weight kg
FIL	400 x ø15	150	125	1.2	M8	0.940

Adapter

Product Number	Description
FIL/UKP	USB Power Adapter DC5V 1A (UK)
FIL/EUP	USB Power Adapter DC5V 1A (EU)

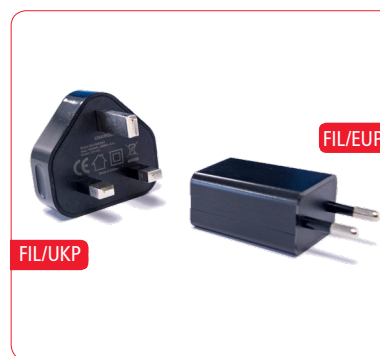

With a Base and Adapter

Product Number	Description	Weight kg
FILSMB/UK	Flexible Inspection Lamp Switchable Magnetic Base UK	2
FILSMB/EU	Flexible Inspection Lamp Switchable Magnetic Base EU	2

Flexible Lamp Permanent Magnetic Base Large

- LED flexible lamp
- Flexible and adjustable body
- Practical magnetic base
- Portable
- Zoom IN/OUT
- ON/OFF button (2 brightness settings)



Product Number	Neck Size mm	Head Diameter mm	Grip Size mm	Magnetic Diameter mm	Battery	Weight kg	Power Rating	LED
FLMBL	450 x ø7.8	20	70 x ø27.5	30	3pcs x AAA	0.245	3W	1pc

Mounting/Measurement

WORKSHOP

Flexible Lamp

- Switchable lamp for assembly, close inspection or work-bench lighting
- Provides "hands-free" lighting in restricted access areas
- Features 30° Beam Angle with 130 lumen light (6400K)
- Adjustable "gooseneck" gives full flexibility to direct light onto work area
- Can be supplied with or without compatible Magnetic Bases

Inspection Lamp

Product Number	Metal Tube mm	Head Diameter mm	Glass Lens Diameter mm	Cable Length mm	Screw Thread mm	Weight kg
FL	600 x ø11	50	33.5	1.2	M8	0.500

Adapter

Product Number	Description
FL/UKP	Power Adapter DC3.3V 600mA (UK)
FL/EUP	Power Adapter DC3.3V 600mA (EU)

With a Base and Adapter

Product Number	Description	Weight kg
FLSMB/UK	Flexible Lamp Switchable Magnetic Base UK	1.7
FLSMB/EU	Flexible Lamp Switchable Magnetic Base EU	1.7



Flexible Lamp Magnetic Base Compact

- The perfect addition to any tool kit
- Zoom in and out
- ON/OFF switch
- Illuminates hard to access areas
- Can be easily attached to any steel surface e.g machine, racking, casings
- Flexible arm allows easy positioning and adjustment
- Also sold in a pack of 12 (FLMBC/POSPACK)



Product Number	Length mm	Magnet Diameter mm	Outer Diameter mm	Weight kg	Pull Force kg	Battery
FLMBC	257	10	12.64	0.04	1.5	LR41 x 3
FLMBC/POSPACK						



A close-up photograph of a welder working on a metal structure. The welder is wearing a white protective mask and is using a welding torch to join metal pieces. Bright sparks are flying from the point of contact. In the upper left corner, there is a red speech bubble containing text.

Did you know?

"Studies suggest that animals & birds use the Earth's magnetic field to navigate"

WELDING

Work Smart with Magnetic Welding Tools

By applying over 100 years of magnetic expertise we have revolutionised traditional methods of clamping during welding, soldering, brazing and assembly processes, gluing and pipe installation.

Our magnetic welding aids provide a fast, secure, accurate alternative which improves efficiency and productivity. With models to suit a variety of securing angles, workpiece sizes and profile, they deliver key benefits over traditional clamping methods:-

- **Speed & Simplicity** – fast, easy set-up, no manual clamps or mounting holes
- **Precision** – switchable models allow precise adjustment
- **Safe** – high strength magnets ensure secure “non-slip” location
- **Versatile** – models available for multi-angles
- **Access** – minimal single face contact allows full access to the workpiece
- **Durability** – minimal maintenance, simple wipe down cleaning

Typical use

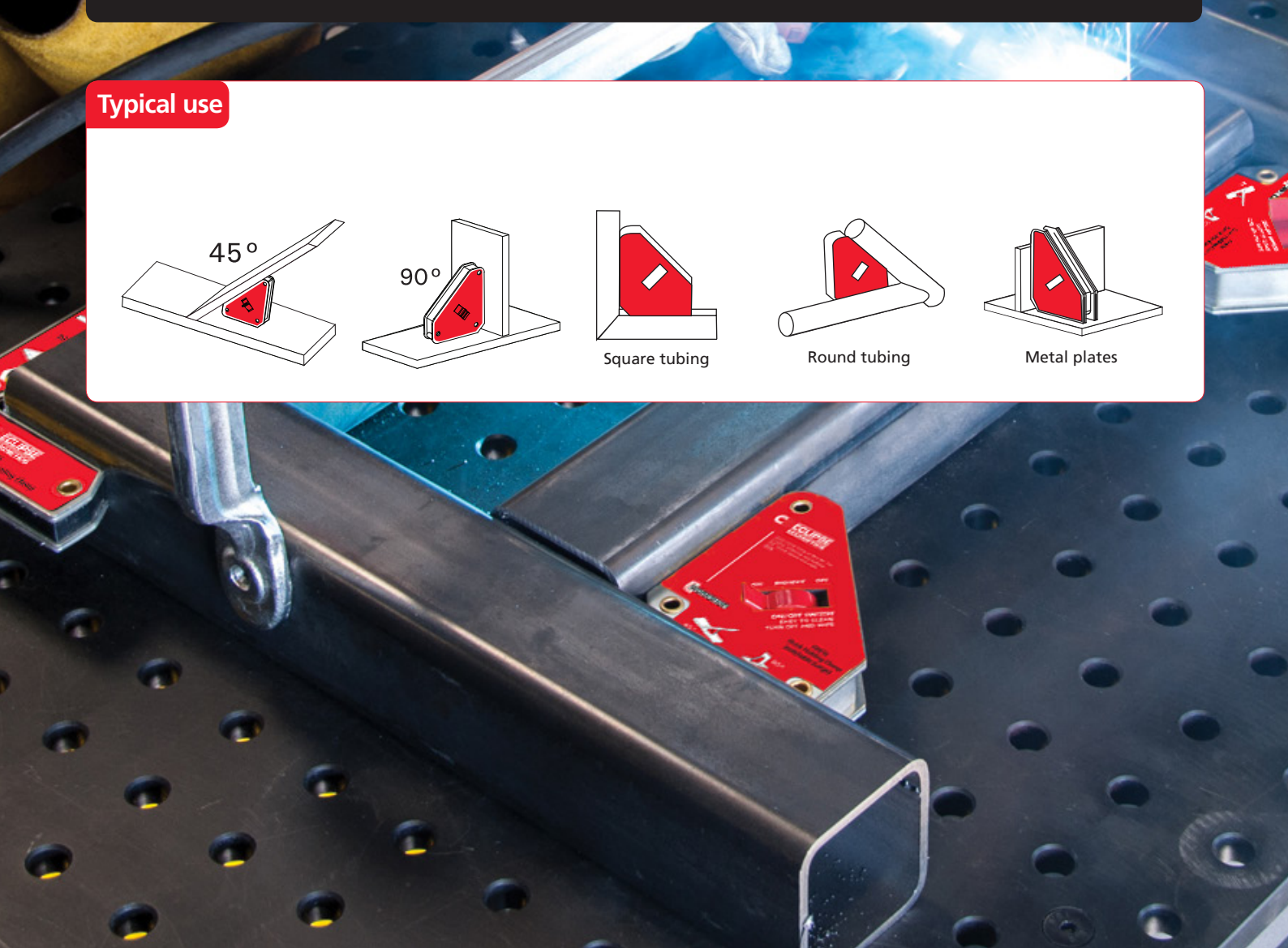
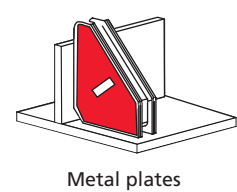
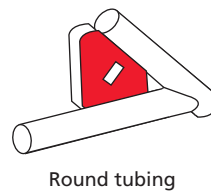
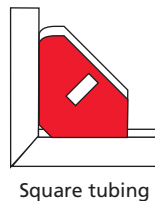
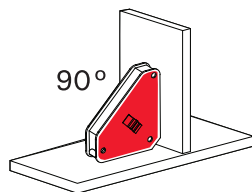
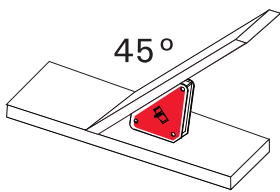

Welding

Magnetic Switchable Welding Aids

Quick Holding Clamp Switchable

- Features ON/OFF switches
- The fast & easy way to hold metal workpieces at 45°, 90°
- Turn the magnet OFF or at the midpoint position when setting up, turn ON when you're ready to work
- Fast and safe set-up!
- Ideal for round and square tubing, angle, and flat stock
- Simple wipe clean design



Product Number	Angles	Dimensions mm	Weight kg	Pull Force* kg
QHCSS	45°, 90°	111 x 95 x 29	0.7	40
QHCSL	45°, 90°	152 x 130 x 35	1.4	75

* Magnetic force is based on the longest side of magnet with 10mm thick steel.

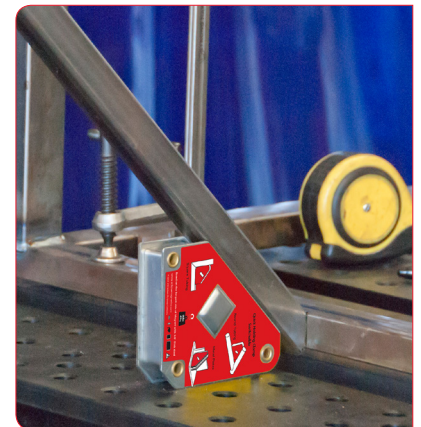
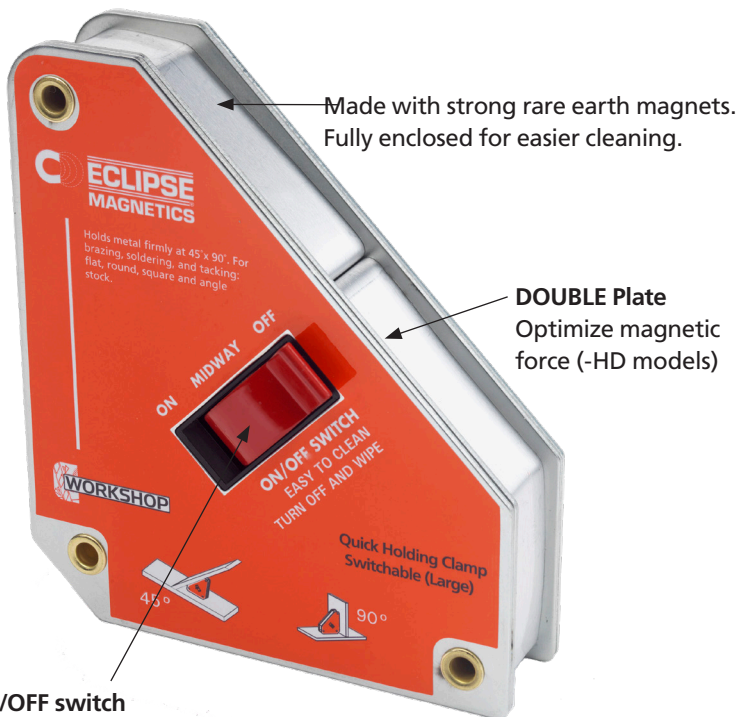

The ON/OFF switch
Mid point switch position: for alignment / easy part placement.

NOTE: Must be used for tack welding only and removed before completing weld. Avoid prolonged exposure of magnetic products to heat sources of 356°F / 180°



WELDING

Magnetic Switchable Welding Aids

90° Fixed Welding Clamps Switchable

- Convenience of ON/OFF switches
- Two ON/OFF switches for independent operation
- **Easy and safe set-up!**
- Machined flat and V-surfaces are ideal for round and square tubing, angle, and flat stock
- Heavy duty construction

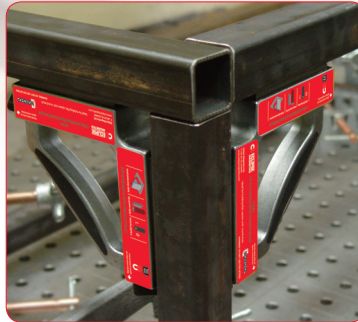

Product Number	Angles	Dimensions mm	Weight kg	Pull Force* kg
FWCSS	90°	152 x 152 x 38	1.2	55
FWCSL	90°	197 x 197 x 48	2.7	120

*Magnetic force is based on 10mm thick steel.

Inside and Outside Welding Clamps

- Hold and position sheet metal, round pipes, square, angled or flat stock
- The Inside and Outside Welding Clamps are constructed from two independent rectangular magnets for consistent, undiminished magnetic force when both sides are attached to workpieces
- Use mounting holes to link two magnets together for use as fixturing elements
- Use hex hole on magnet for breakaway leverage

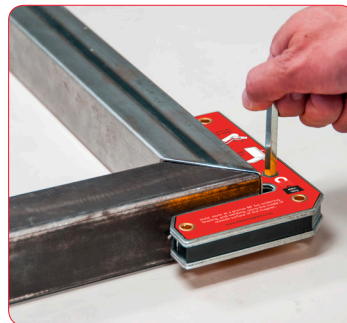

Product Number	Angles	Height mm	Width mm	Thickness mm	Weight kg	Pull Force kg
IOWCC*	30°, 60°, 90°	75.5	52	14	0.13	9
	30°, 60°, 90°	125	85	18	0.415	15
IOWCL	30°, 60°, 90°	165	110	20	0.8	18

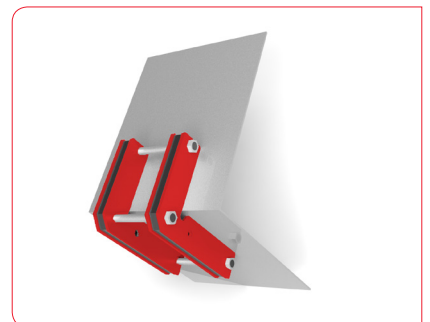

NOTE: Must be used for tack welding only and removed before completing weld. Avoid prolonged exposure of magnetic products to heat sources of 356°F / 180°

Magnetic Welding Aids

Variable Welding Clamp

- Fast accurate holding of ferrous sheets and tubes for welding and assembly work
- Variable from 25° to 280°

Product Number	Angles	Length mm	Height mm	Width mm	Weight kg	Pull Force kg
E952	25°-280°	195	200	11	0.49	20



Heavy Duty Variable Welding Clamp

- Clamps components during welding, fabrication and assembly
- Powerful 40kg clamping force, enables larger components to be clamped with ease

Product Number	Angles	Length mm	Height mm	Width mm	Weight kg	Pull Force kg
E974	45°-90°	140	140	35	1.40	40



90° Fixed Welding Clamps

- Two magnetic faces in a rigid 90° angle for jiggling on sheets, pipes and tubes
- A fast and cost effective means of clamping components rigid at 90° angles during fabrication, assembly and weld preparation applications



E971



E972

Product Number	Angles	Length mm	Height mm	Width mm	Weight kg	Pull Force kg
E971	90°	140	140	35	1.40	40
E972	90°	225	225	22	2.20	75
E973	90°	300	300	35	4.70	200



E973

WELDING

Magnetic Welding Aids

Quick Holding Clamps

- Fast and accurate holding of ferrous metals at different fixed angles
- Also suitable for retrieval applications

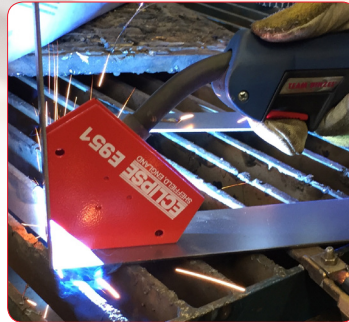

Product Number	Angles	Length mm	Height mm	Width mm	Weight kg	Pull Force kg
E951	30°, 45°, 60°, 75°, 90°	100.5	65.5	12	0.3	10
E953	30°, 45°, 60°, 75°, 90°	100.5	65.5	20	0.4	15

Quick Holding Clamp Pack Set

- Cost effective, retail friendly pack of 4, easy to apply welding clamps



Product Number	Angled	Length mm	Width mm	Depth mm	Net Weight kg	Pull Force kg	Units / Pack
QHPCS	45°, 90° & 135°	58.7	51.1	12.1 (13.7 at rivets)	0.400	4	4

Mitre Clamps

- Effective and inexpensive method of clamping flat (923) or round (924) ferrous components

Product Number	Angles	Length Base Face mm	Length Top Face mm	Height mm	Width mm	Weight kg	Pull Force kg
923	45°, 90°	156	66	45	43	1.36	100
924	45°, 90°	184	94	45	43	1.64	68



Magnetic Welding Aids

Heavy Duty Welding Clamps

- Holds workpieces at an exact 45° or 90° angle to each other
- 10kg and 15kg of magnetic pull make these ideal for a range of workshop welding and applications

Product Number	Angles	Depth mm	Height mm	Width mm	Weight kg	Pull Force kg
E954	45°, 90°	14	82	120	0.3	10
E955	45°, 90°	18	102	160	0.7	15



Holdfasts

- Supplied with screw release handle
- Can be built into workholding, handling and assembly fixtures to provide a high clamping force and positive grip

Product Number	Diameter mm	Height mm	Fixing Holes PCD mm	Holes	Weight kg	Pull Force kg
E939	44.5	44.5	31.75	2 x M8	0.6	20
E940	54.0	49.2	38.1	2 x M8	1.0	40
E941	70.0	64.5	50.8	2 x M8	2.0	88
E942	101.6	74.6	69.0	3 n/a	4.7	183



Weld Holder

- Provides the welder with a powerful, rigid support on flat and round components at various angles during welding preparation applications

Product Number	Length mm	Height mm	Width mm	Weight kg	Pull Force kg
E925	108	140	108	5.67	100



Steel Plate Drag

- Used to remove steel sheets from a stack and transport sheets to and from machines
- Contains permanent ferrite magnets in an aluminium housing

Product Number	Length mm	Height mm	Width mm	Weight kg	Pull Force kg
E964	118	98	38	2.8	170



WELDING

Magnetic Welding Aids

Positioners

- 2 magnetic blocks connected by 2 non magnetic steel straps
- The blocks contain ferrite magnetic material
- Magnetic on 2 faces
- ON / OFF switch located at each end

Product Number	Length mm	Height mm	Width mm	Weight kg	Pull On Flat Face kg	Pull On V Face kg
922	206	63.5	76	3.17	80	80
922SU	63.5	63.5	51	1.48	80	80

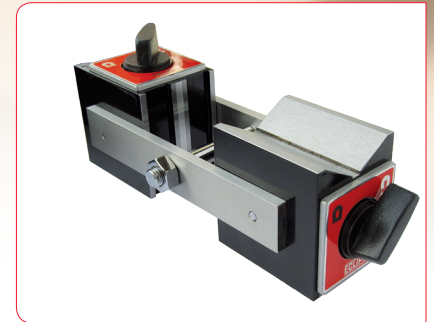

Adjustable Links

- Ferrite magnetic material
- Clamp components at any angle for welding and assembly applications

Product Number	Length mm	Height mm	Width mm	Weight kg	Pull Force kg
920SU (Single)	60	25	29	0.35	12
920 (Pair)	127	25	51	0.70	12

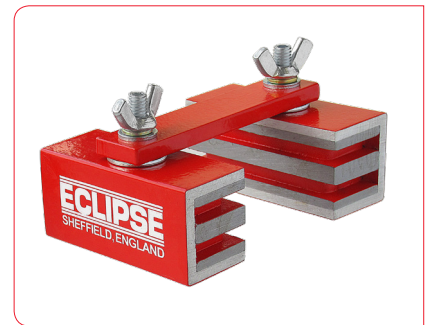

Adjustable Clamping Links

- Alnico magnetic material
- Clamp components at any angle for welding and assembly applications

Product Number	Length mm	Height mm	Width mm	Weight kg	Pull Force kg
920SUOT (Original Single)	60	25	25	0.32	12
920OTPR (Original Pair)	127	25	48	0.70	12



Earth Welding Clamp

- Quick and easy earthing for most steel welding operations
- Provides earthing / ground on large welding operations where croc-clip or G-Clamps cannot be easily used

Product Number	Width mm	Height mm	Length mm	Weight kg	Pull Force kg	Maximum Current amps
E946	90	64	193	1.6	25	800



Did you know?

"Magnets are present in many everyday items e.g. phones, TV's, Audio Equipment, Computers"

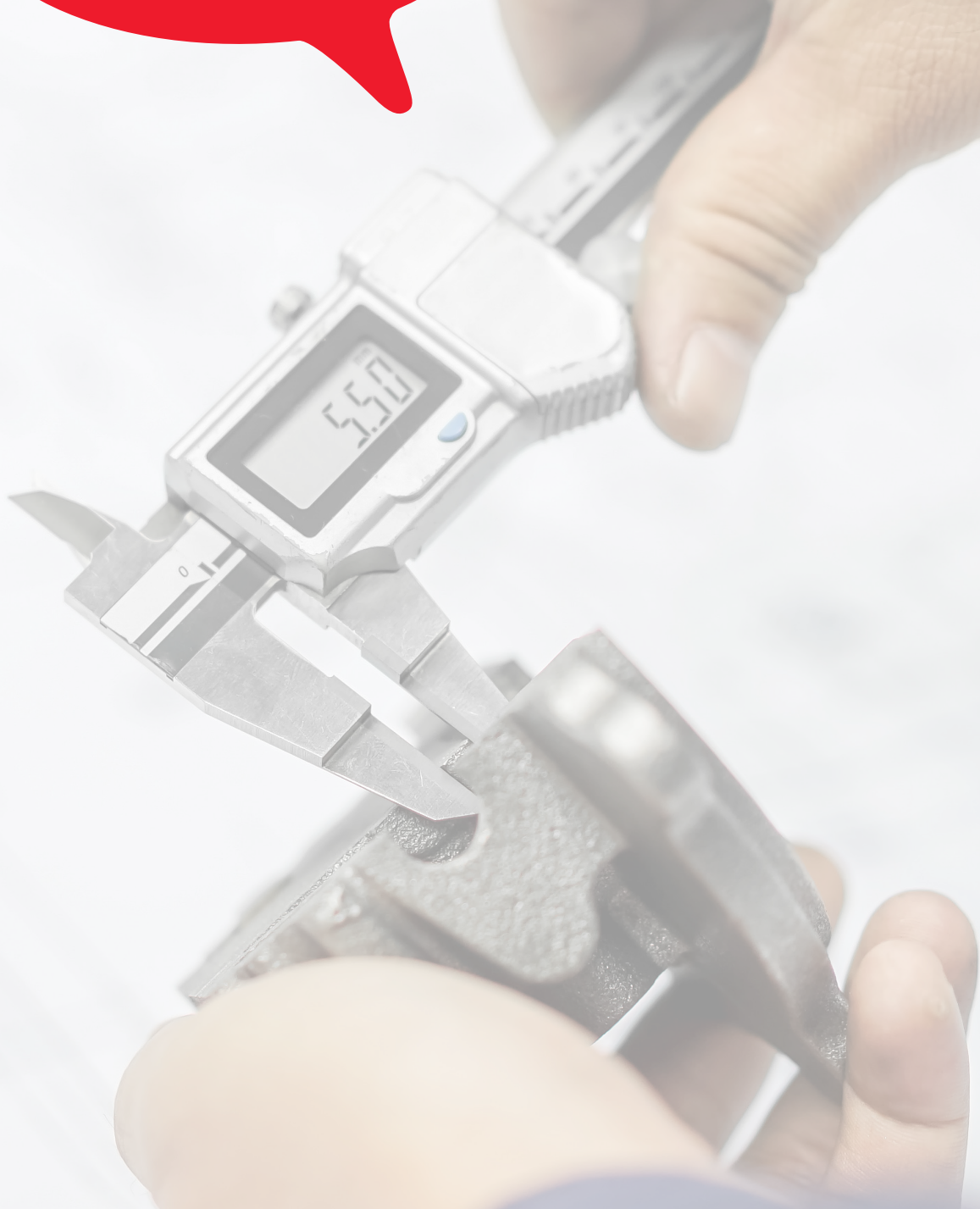



PRECISION

Work Smart, improve speed and accuracy with magnets.

Our Precision range drives business efficiencies by providing quick and easy set-up, whilst maintaining pinpoint accuracy. The range includes Magnetic Bases for mounting measuring and optical instruments, and Magnetic Chucks for machining operations.

Precision - Magnetic Bases

Applying magnetics makes precision measurement and inspection a simple, trouble-free process. Available with a variety of precision fitment arms, each base is supplied complete with a simple on/off mechanism for fast and accurate engagement.

Typical applications

- Dial test indicator securing
- Holding and positioning lights
- Mounting visual inspection instruments
- Mounting photographic equipment
- Mounting measuring equipment

Precision – Magnetic Workholding

Since making the world's first permanent magnetic chuck in 1934 we have remained at the forefront of workholding systems. We provide a range of high performance permanent magnetic chucks for grinding and other surface finishing applications.

Specifying an Eclipse Magnetics' chuck provides an array of advantages over traditional clamping and holding methods:-

- Faster set up, feed rates achievable
- Instant, single surface clamping
- Allows 5 face machining – minimal repositioning
- Failsafe – magnetic technology guarantees a secure hold
- 100% consistent clamping – across entire surface
- Eliminates vibration or "chatter"

Precision

(≤18.00")

400P
(880)

Workholding

Premier Range Chucks

Premier Range chucks provide precision performance and durability.

Eclipse Magnetics invented the first permanent magnet chuck in 1934 and we continue to set the benchmark for quality workholding with today's Premier Range.

Premier Range Chuck - Circular

- Unique top plate concentrates magnetic energy on to the chuck face
- The chucks can be partially magnetised to aid the correct positioning of the workpiece
- Grooved rings in the top plate assist in visual positioning to aid quick changeover
- Excellent for holding thin ring-shaped components that can be subject to radial distortion



Product Number	A mm	B mm	C mm	D mm	E mm	F mm	G mm	Weight kg
AX475C/P	121	45	50.8	6.5	76.2	M6	101.6	4.23
AX651C/P	167	60	76.22	6.5	101.6	M10	139.7	9.66
AX91C/P	229	60	85.8	6.5	114.3	M10	190.5	20
AX12C/P	305	72	152.4	4.75	184.15	M12	254	45.5

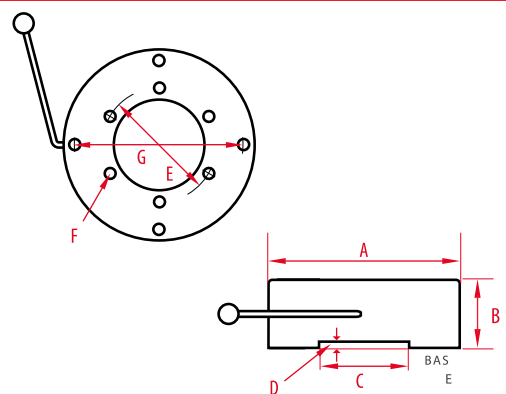

Workholding

PRECISION

Premier Range Chuck - Radial Pole

- Dynamically balanced to enable use at high RPM
- All metal top plate and a rugged industrial build ensures accuracy and longevity
- Through-bored (except NRC100C) allows through-flushing of coolant during machining
- Optional centre plug available

Product Number	A mm	B mm	C mm	D mm	E mm	F mm	G mm	H mm	I mm	No. Of Poles	Weight kg
NR100C	100	48	50.8	6.5	N/A	M6	76	N/A	N/A	6	3.08
NR150C	150	69	76.2	4	N/A	M10	102	32	36	10	8.79
NR225C	225	71	85.8	5	114.3	M10	190.5	50	54	14	18.5
NR300C	300	71	152.4	54.75	184.15	M12	354	62	66	18	40

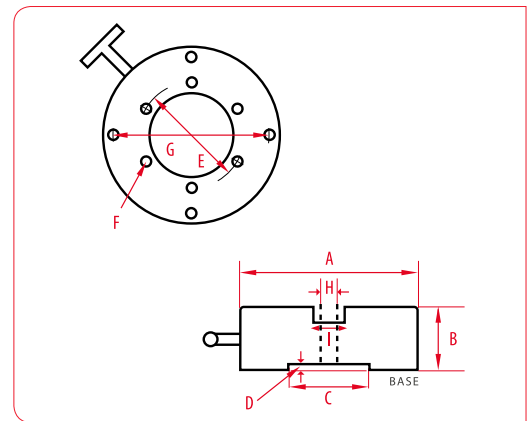

Premier Range Chuck - Rectangular

- Unique top plate concentrates magnetic energy on to the chuck face
- The all-metal top plate is extra thick to ensure accuracy after frequent re-grinding
- Chrome plated side and end stops for packing and positioning
- The chucks can be partially magnetised to allow part positioning
- Removable, ergonomically designed handles allow easy switching

Product Number	Length mm	Height mm	Width mm	Pole Pitch	Weight kg
AX47/P	203	42	127	17.6	8.2
AX510/P	276	53	129	35	16
AXS612/P	322	63	151	32	22
AXS614/P	360	63	151	32	22
AXS618/P	451	63	151	32	36
AXM824/P	601	63	201	35	56



Precision

Workholding

Standard Range Chucks

Standard Range chucks provide high performance at a competitive price

- Clamping force: 80N/cm² on test piece Steel ring 52mm Ø outer 38mm Ø inner, 10mm thick
- Brass and steel top plates
- All chucks are supplied with side and end stops, and with clamps
- Removable hexagon key handles ensure ease of operation through a 180 degree arc

Standard Pole

Pole Spacing: 4.0mm steel - 2.0mm brass
Effectively clamps all workpiece thicknesses down to 3mm



Fine Pole

Pole Spacing: 1.5mm steel - 0.5mm brass
Ideal for small workpieces less than 3mm in height



Standard Range Chucks - Circular

Product Number		A	B	C	D	E	F	G	Weight
Standard	Fine	mm	mm	mm	mm	mm	mm	mm	kg
ECSP100	ECFP100	100	50	50.8	6.35	76.2	M6	N/A	6
ECSP125	ECFP125	125	50	50.8	6.35	76.2	M6	101.6	9.38
ECSP160	ECFP160	160	50	76.2	6.35	101.6	M10	139.7	13.50
ECSP195	ECFP195	195	50	76.2	6.35	101.6	M10	139.7	18
ECSP255	ECFP255	255	50	85.7	6.35	114.3	M10	190.5	22.50
ECSP310	ECFP310	310	50	152.4	6.35	184.1	M12	254	32
ECSP350	ECFP350	350	50	196.8	6.35	234.9	M12	N/A	40

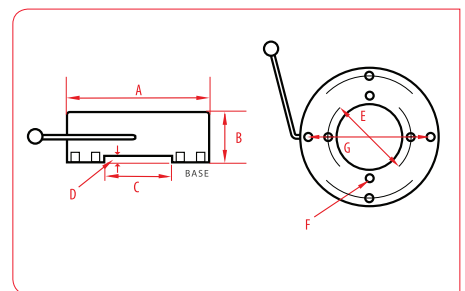

Standard Range Chucks - Rectangular

Product Number		Length	Width	Height	Weight
Standard	Fine	mm	mm	mm	kg
ERSP1018	ERFP1018	180	100	50	9.5
ERSP1325	ERFP1325	255	130	50	15
ERSP1530	ERFP1530	300	150	50	20.5
ERSP1535	ERFP1535	350	150	50	23.5
ERSP1545	ERFP1545	450	150	50	30
ERSP2060	ERFP2060	600	200	50	52



Workholding

PRECISION

Chuck Blocks

- Use to extend the flux paths of a magnetic chuck with parallel poles
- Can be machined to accommodate awkward workpieces

Product Number	Length mm	Height mm	Width mm	Pole Direction kg	Weight kg
950	60	30	75	Longitudinal*	2.4
950v	50	40	100	Longitudinal*	2.4

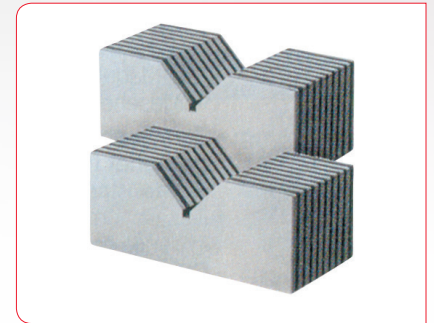

*Along width

Simple Magnetic Sine Tables Short Lift

- Accuracy of sine table within (+/- 5 secs of arc)
- Pole spacing 2mm (1.5mm Steel 0.5mm Brass)
- Clamping force 80N/cm²

Product Number	Chuck	Top Plate mm		Base mm		Height At Zero mm	Weight kg
		Length	Width	Length	Width		
SSTFP1018	ERFP1018	180	100	215	115	73	12
SSTFP1325	ERFP1325	255	130	295	195	78	24
SSTFP1535	ERFP1535	350	150	390	165	89	39



'V' Blocks

- 'V' blocks are ideal for holding cylindrical and complex workpieces for marking, spark erosion, grinding and measurement operations
- Can be used on its base, side or end

Product Number	Width mm	Length mm	Height mm	Max diameter of workpiece		Weight kg
				Top 'V' mm	Bottom 'V' mm	
25 Micron Accuracy						
E934	70	101.6	95	65	22	1.98
E934MP	70	101.6	95	65	22	3.96
E935	70	80	95	65	22	3.12
E935MP	70	80	95	65	22	6.24
10 Micron Accuracy						
E933A	70	120	95	65	22	4.4
E934MPA	70	120	95	65	22	8.8
E935A	70	80	95	65	22	2.95
E935MPA	70	80	95	65	22	5.9



Precision

(≤18.00")

400P
(880)

Mounting/Measurement

Custom Solutions in 3 Easy Steps

A customised Eclipse Magnetics magnetic base holding system can be constructed from our wide range of components.

Step 3 - Choose Power Supply



Step 2 - Choose Arm

Step 1 - Choose Base

PRECISION

Mounting/Measurement

Step 1 - Choose Base

Product Number	834	E905WF/50	E900WF	E901WF	E905WF	E905WF/100	E905WF/AF	E905WF/130	
Magnet	Permanent	Switchable							
Hold kg	14.75	50	30	80	80	100	50	130	
Screw Thread	M6		M8					M10	

Step 2 - Choose Arm

Product Number	RP909FIT	RP999S	RP72CP	RP991BL	RP995BL	RP901/1	RP907S	RP999	FL	FIL	RP999L
Clamp Hole mm	8.0	6.0/8.0/ Dovetail	8.0	4.5/8.0	4.5/8.0	6.5/8.0	8.0/ Dovetail	8.0/ Dovetail	LED Lamp	LED Lamp	6.0/8.0/ Dovetail
Screw Thread	M6		M8								M10

Step 3 - Choose Power Supply

Product Number	FL/UKP	FL/EUP	FIL/UKP	FIL/EUP
Plug Type	UK Plug	EU plug	UK Plug	EU Plug
To Fit	FL		FIL	



Alternative Option

Product Number	FLTC
Plug Type	Table Clamp
To Fit	FL



Precision

Bases

(≤18.00")

400P
(880)

Magnetic Bases with Toggle Switch

- Toggle switched magnetic bases to hold Eclipse Magnetics fitments for inspecting workpieces
- Can be located on any ferrous surface to provide rigid support
- Magnetic on 3 sides
- Can clamp onto curved and flat surfaces



E905WF/50



E905WF/130

Product Number	Length mm	Width mm	Height g	Screw Thread mm	Hold kg	Weight kg
E905WF/50	40	40	40	M6	50	0.405
E905WF	65	50	55	M8	80	0.960
E905WF/100	75	50	55	M8	100	1.200
E905WF/130	117	50	55	M10	130	1.900

Magnetic Bases with Push Button Switch

- Eclipse Magnetics bases can be attached to any ferrous surface to provide a rigid support
- 4 magnetic faces

Product Number	Length mm	Width mm	Height mm	Screw Thread mm	Weight kg	Hold kg
E900WF	48	40	52	M8	0.5	30
E901WF	64	64	76	M8	1.70	80



Permanent Magnetic Base

Product Number	Width mm	Height mm	Screw Thread mm	Hold kg	Weight kg	Pull Force kg	Units/ Pack
834	35	30	M6	14.75	0.184	14.75	2



Switchable ANYFORM Magnetic Base

- Versatile, with adjustable base profile which allows use on any ferrous surface
- Ideal for irregular or uneven surfaces

Product Number	Length mm	Width mm	Height mm	Thread Size	Weight kg	Hold kg
E905WF/AF	91	30	55	M8	0.88	50

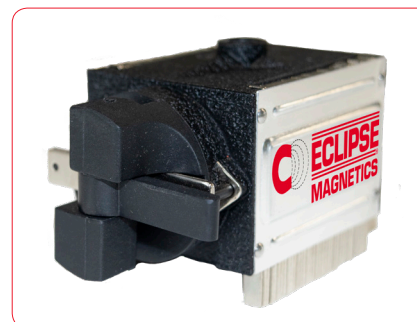

Fitments

PRECISION

- Wide range of options for mounting components such as measuring instruments and lighting
- Feature robust flexible arms with secure tightening/positioning
- Available with fine adjustment crossbar for precision measurement
- Complete with screw thread base for attaching to magnetic bases or direct to machine
- Flexible/snake arm version available

Light Duty

Product Number	Pillar Height mm	Pillar Diameter mm	Crossbar Length mm	Crossbar Diameter mm	Screw Thread mm	Weight kg	Diameter of Clamp Hole mm
RP72CP	185	12.5	150	6.3	M8	0.358	8.0

With a Base

Product Number	Base Part Number	Hold kg
E903/CP	E900WF	30



Heavy Duty with Fine Adjustment

Product Number	Pillar Height mm	Pillar Diameter mm	Crossbar Length mm	Crossbar Diameter mm	Screw Thread mm	Weight kg	Diameter of Clamp Hole mm
RP991BL	175	12	165	10	M8	0.444	4.5/8.0 (with sleeve)

With a Base

Product Number	Base Part Number	Hold kg
E901	E901WF	80
E906	E905WF	80



Heavy Duty

Product Number	Pillar Height mm	Pillar Diameter mm	Crossbar Length mm	Crossbar Diameter mm	Screw Thread mm	Weight kg	Diameter of Clamp Hole mm
RP995BL	175	12	165	10	M8	0.445	4.5/8.0 (with sleeve)

With a Base

Product Number	Base Part Number	Hold kg
E908M	E900WF	30
E905	E905WF	80



Precision

Fitments

Extra Large Heavy Duty

Product Number	Pillar Height mm	Pillar Diameter mm	Crossbar Length mm	Crossbar Diameter mm	Screw Thread mm	Weight kg	Diameter of Clamp Hole mm
RP901/1	300	20	200	14	M8	1.000	6.5/8.0

With a Base

Product Number	Base Part Number	Hold kg
E901/1	E901WF	80



E901/1



One Pillar

Product Number	Pillar Height mm	Pillar Diameter mm	Screw Thread mm	Weight kg	Diameter of Clamp Hole mm
RP909FIT	120	6	M6	0.090	8.0

With a Base

Product Number	Base Part Number	Hold kg
E909	834	14

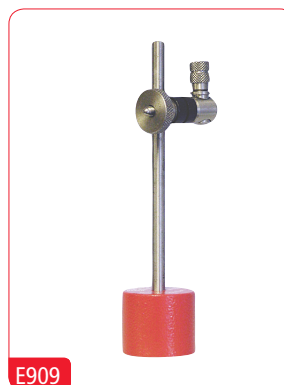

E909

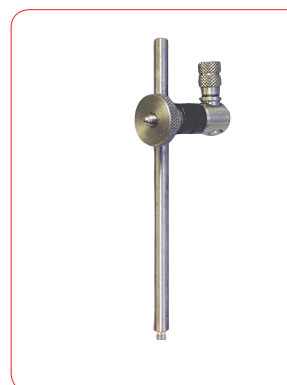

Flexible Snake Arm Fine Adjustment

Product Number	Maximum Extension mm	Screw Thread mm	Weight mm	Diameter of Clamp Hole mm
RP907S	355	M8	0.332	8.0/Dovetail

With a Base

Product Number	Base Part Number	Hold kg
E907M	E905WF	80



E907M



Fitments

PRECISION

Mechanical Fitment Stand (Small)

Product Number	Maximum Extension mm	Screw Thread mm	Weight mm	Diameter of Clamp Hole mm
RP999S	162	M6	0.175	6.0/8.0/Dovetail (with sleeve)

With a Base

Product Number	Base Part Number mm	Hold kg
E910S	E905WF/50	50



Mechanical Fitment Stand

Product Number	Maximum Extension mm	Screw Thread mm	Weight mm	Diameter of Clamp Hole mm
RP999	295	M8	0.272	8.0/Dovetail

With a Base

Product Number	Base Part Number	Hold kg
E910	E905WF	80



Mechanical Fitment Stand (Extra Large)

Product Number	Maximum Extension mm	Screw Thread mm	Weight mm	Diameter of Clamp Hole mm
RP999L	650	M10	2.945	6.0/8.0/ Dovetail (with sleeve)

With a Base

Product Number	Base Part Number	Hold kg
E910L	E905WF/130	130



Precision

Fitments LED Lamp

Flexible Lamp

- Switchable lamp for assembly, close inspection or work-bench lighting
- Provides “hands-free” lighting in restricted access areas
- Features 30° Beam Angle with 130 lumen light (6400K)
- Adjustable “gooseneck” gives full flexibility to direct light onto work area
- Can be supplied with or without compatible Magnetic Bases

Product Number	Metal Tube mm	Head Diameter mm	Glass Lens Diameter mm	Cable Length mm	Screw Thread mm	Weight kg
FL	600 x ø11	50	33.5	1.2	M8	0.500

Adapter

Product Number	Description
FL/UKP	Power Adapter DC3.3V 600mA (UK)
FL/EUP	Power Adapter DC3.3V 600mA (EU)

With a Base and Adapter

Product Number	Description	Weight kg
FLSMB/UK	Flexible Lamp Switchable Magnetic Base UK	1.7
FLSMB/EU	Flexible Lamp Switchable Magnetic Base EU	1.7



Table Clamp

NB: ONLY suits Flexible Lamp FL.

Product Number	Clamp Capacity mm	Screw Thread mm	Weight kg
FLTC	0-55 Thickness	M10	0.0140



Fitment LED Lamp

PRECISION

Flexible Inspection Lamp

- Switchable lamp with magnifying glass for close inspection or intricate, detailed work
- Ideal for use in quality inspection, model making, precision finishing
- 10 x magnification factor allows you to work with confidence
- Features flexible support arm for adjusting angle/direction
- Can be supplied with or without compatible Magnetic Bases



Product Number	Metal Tube mm	Head Diameter mm	Glass Lens Diameter mm	Cable Length mm	Screw Thread mm	Weight kg
FIL	400 x ø15	150	125	1.2	M8	0.940

Adapter

Product Number	Description
FIL/UKP	USB Power Adapter DCSV 1A (UK)
FIL/EUP	USB Power Adapter DCSV 1A (EU)



With a Base and Adapter

Product Number	Description	Weight kg
FILSMB/UK	Flexible Inspection Lamp Switchable Magnetic Base UK	2
FILSMB/EU	Flexible Inspection Lamp Switchable Magnetic Base EU	2



Did you know?

"When a magnet is cut into 2 pieces it will form 2 individual magnets"





Work Smart with our Magnetic Display Materials

We offer a range of simple magnetic solutions for fixing, holding or hanging display materials in retail and other commercial environments. These value adding options have been developed for maximum visual impact with easy/trouble free application and removal. The cost-effective range incorporates a variety of materials and innovative designs.

Typical Applications

- Retail Point-Of Sale
- Banner hanging
- Office/Workplace labelling
- Racking/Bay markers
- Vehicle livery/signage
- Notice board displays
- Exhibition graphic mounting
- Secondary glazing fitting
- Showroom signage
- Label holders

Display

(≤18.00")

400P
(880)

Magnetic Tape

- Material: Strontium ferrite in thermo-plastic binder
- Max operating temperature: 80°C
- Magnetic on 1 face only
- Can be cut with scissors

All supplied with standard acrylic adhesive. FM652, FM663, FM664, FM665 are also available with premium acrylic or foam adhesive.

Product Number	Width mm	Thickness mm	Length m	Weight kg	Pull Force g/cm ²	Units / Pack
EM884-R	13	0.5	1	0.027	28	1
FM660	7.5	0.75	10	0.240	44	1
FM661	12.5	0.75	10	0.390	44	1
FM662	20	0.75	10	0.630	44	1
FM652	10	1.5	30	1.7	55	1
FM663	12.7	1.5	30	2.1	55	1
FM664	20	1.5	30	3.3	55	1
FM665	25.4	1.5	30	4.2	55	1

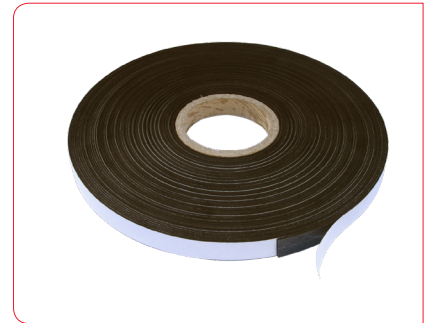

Steel Tape

- Adhesive-backed steel tape can be used with the matching width adhesive backed magnetic tape to provide temporary and semi-permanent fixings
- Supplied with standard acrylic adhesive.

Product Number	Matching Magnetic Tape mm	Width mm	Thickness mm	Roll Length m	Weight kg	Units / Pack
FM667	FM663	13	0.2	30	0.8	1
FM668	FM664	20	0.2	30	1.2	1
FM669	FM665	25	0.2	30	1.5	1

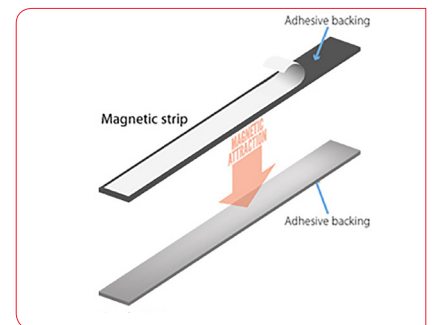

Display

DISPLAY

Magnetic Extrusion

- Material: Strontium ferrite in thermo-plastic binder
- Max operating temperature: 80°C
- Magnetic on 1 face only
- Forms a strong bond when paired with itself

Please contact us if you require custom extruded profiles

Product Number	Width mm	Thickness mm	Length m	Weight kg	Pull Force g/cm ²	Units / Pack
EM888-R (Pairs) *	9.5	3.6	0.15	0.021	65	1 Pair
EM880-R	9.5	3.6	2	0.026	65	1
FM670	9.5	3.6	10	1.44	65	1
FM671	11	4.6	10	2.07	65	1
FM672	15	6.4	10	3.64	65	1



*Adhesive Backed

Magnetic Sheet

- Max operating temperature: 80°C
- Magnetic on 1 face only
- UV Coating for cleaner handling.
- Flexible and impact resilient but can be easily cut with scissors
- Regular shapes can be cut using inexpensive dies

Available with plain, white gloss or standard acrylic adhesive backing. Coloured and dry wipe finishes available.

Please contact us for details.

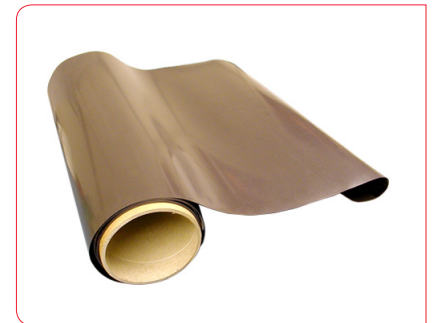

Product Number	Thickness mm	Width mm	Roll Length m	Weight kg	Pull Force g/cm ²	Finish
060510A2	0.5	620	30	35	28	Plain
060710A2	0.75	620	30	53	44	Plain
060524A2	0.6	620	30	43	28	Gloss Vinyl White
060724A2	0.85	620	30	60	44	Gloss Vinyl White
060724D2	0.85	620	15	30	44	Gloss Vinyl White
060724X5	0.6	1000	10	23	28	Gloss Vinyl White
060724X4	0.85	1000	10	33	44	Gloss Vinyl White
060711A2	0.8	620	30	60	44	Adhesive Backed

Product Number	Thickness mm	Width mm	Tile Length m	Weight kg	Pull Force g/cm ²	Finish	Units / pack
FM650	0.75	150	0.15	0.071	44	Adhesive	5

Display

(≤18.00")

400P
(880)

Labelling

3 ways to make your own custom magnetic labels:

- Print with laser printer or inkjet on to matt or gloss magnetic paper
- Apply self adhesive magnetic sheet to the back of labels, signs and graphics
- Write on dry-wipe flexible magnetic sheet



All materials are easily cut with scissors

Product Number	Description	Application	Size	Thickness mm	Finish	Units / Pack
FM651	Magnetic paper	Laser / Inkjet Printing	A4	0.25	White Matt	10
060511D1	Self adhesive magnetic sheet	Application to existing card / label	Business Card (85x55)	0.6	Adhesive Backed	25
060711Y6	Self adhesive magnetic sheet	Application to existing card / label	A4	0.8	Adhesive Backed	10
060510U14	Dry wipe magnetic sheet	Dry-wipe marker	A4	0.6	White Dry-Wipe	10

Labelling Holders

- Temporary / permanent signage, identification
- Can be used on steel racking, cabinets, shelving or any magnetically receptive surface
- Complete with magnetic rubber, white card and cover



Product Number	Width mm	Height mm	Units / Pack	Weight kg
FM676/B	100	25	50	1
FM677/B	100	30	50	1
FM683	150	35	5	0.125

Product Number	Roll Length m	Height mm	Units / Pack	Weight kg
FM674C	50	15	1	7
FM676C	50	25	1	7
FM677C	50	30	1	7

Marker Magnets

- Magnet material in a coloured plastic shell
- Ideal for filing cabinets, fridge doors and noticeboards

Diameter mm	Yellow	Blue	Red	White	Green	Black	Orange
20	RM765/Y	RM765/BLU	RM765/R	RM765/W	RM765/G	RM765/BLK	RM765/O
30	RM768/Y	RM768/BLU	RM768/R	RM768/W	RM768/G	RM768/BLK	RM768/O



Display

DISPLAY

Racking Strip & Bay Markers

- Sticks to all steel racking
- Dry-wipe surface - write on, wipe off
- Supplied in 10 metre rolls
- Thickness: 0.5mm



Width mm	Yellow	Blue	Red	White	Green
20	060510U8/Y	060510U8/B	060510U8/R	060510U8/W	060510U8/G
30	060510U9/Y	060510U9/B	060510U9/R	060510U9/W	060510U9/G
50	060510U10/Y	060510U10/B	060510U10/R	060510U10/W	060510U10/G
70	060510U11/Y	060510U11/B	060510U11/R	060510U11/W	060510U11/G
90	060510U12/Y	060510U12/B	060510U12/R	060510U12/W	060510U12/G

Ferrite Shallow Pots with Hooks

- Max. operating temperature: 120°C
- Mild steel pot painted white
- Ideal for retail or general display applications
- For hanging graphics, utensils, tools etc



Product Number	Diameter mm	Height mm	Thickness mm	Thread	Weight g	Pull Force kg	Units / Pack
E879-RB	25	8	34	M4	27	4.0	1
E880-RB	32	8	34	M4	34	8.0	1
E881-RB	36	8	34	M4	38	10.0	1

Neodymium Shallow Pots with Hook

- Zinc plated body with threaded stem
- Maximum operating temperature of 80°C
- Used in point of sale



Product Number	Diameter mm	Thickness* mm	Overall Height Inc. Hook mm	Thread mm	Weight g	Pull Force kg	Units / Pack
E1030/NEO	10	4.5	15	M3	4.5	2.5	20
E1031/NEO	13	4.5	15	M3	7.5	6.0	20
E1032/NEO	16	4.5	20.5	M4	13.2	9.5	20
E1033/NEO	20	6	22	M4	16.5	14.0	10
E1034/NEO	25	7	23	M4	34	20.0	10
E1035/NEO	32	7	30	M5	48	35.0	5

Let your business "Work Smart with Magnets"

Businesses around the world are benefiting from "Working Smart with Magnets". Our products are now widely used typical industries such as:-

Garage and Motor Repairs

Magnetic tools save time and stress in a variety of garage situations

- Tool and component storage and carrying
- Notice boards display
- Retrieving fixings, screws, tools from inaccessible places
- Attaching temporary signage – number plates etc
- Keeping floor spaces clean and safe
- Inspection light mounting
- Welding fixings
- Lifting large or heavy steel components

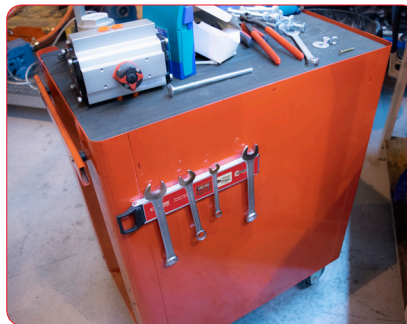

Retail

Magnets are widely used in retail as a versatile option for ease of application/removal:-

- Ceiling magnets for hanging banners
- Notice board display
- Mounting wall signage for easy application/removal
- Graphics applied to curved surfaces
- Wall mounted product hangers
- Shelf/racking labelling
- Shopfitter tool storage





Electrical

Magnetic products are often the answer for specialist electrical applications

- OEM design projects – motors, locking systems
- Cable management
- Tool and component storage and carrying
- Retrieving items from wall cavities or under flooring
- Light source in dark areas
- Mounting inspection or lighting equipment



Warehouse/Distribution Centres

Magnetic products offer a quick and easy solution for any of the following:-

- Notice board and planner displays
- Removable racking bay markers
- Retrieving lost items from inaccessible places
- Keeping vehicle bays and car parks free from sharp ferrous items
- Maintenance tool storage
- Attaching temporary vehicle signage

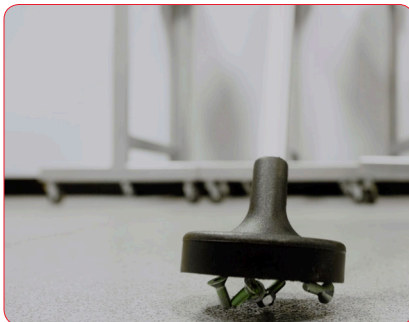

Guide to Magnet Materials

When choosing a magnet material for an application you should take the following factors into consideration:

- Flux requirement of the application
- Maximum operating temperature
- Likely exposure to corrosive conditions
- Magnetic stability
- Size and weight limitations

What strength/flux of magnet do you need?

This table shows the comparative magnetic strengths of the same volume of the four main magnet materials in terms of their maximum energy products (BH_{max}) in CGS or SI units and their typical pole face flux densities.

Neodymium is the most powerful magnet material available. It is ideal for applications where high flux density is required or where space is at a premium.

Magnet Material	Max Energy Product: CGS	Max Energy Product: SI	Flux Density
Ferrite	3.3 MGOe	26 KJ/m ³	1000 Gauss
Alnico	5.2 MGOe	42 KJ/m ³	1300 Gauss
Samarium Cobalt	26 MGOe	208 KJ/m ³	3500 Gauss
Neodymium	35 MGOe	279 KJ/m ³	4500 Gauss

What temperature will the magnet be operating in?

In most applications, operating temperature is not a consideration but extreme temperatures will have an effect on the magnetic performance.

Each material has different temperature characteristics and these must be reviewed to ensure that the correct material is used for the application. Using the wrong material could lead to loss in magnetic performance.

Magnet Material	Max Working Temperature °C	Effects of Sub Zero Temperature °C	Reversible Effect of Temp: 20°C - 150°C
Ferrite	250	Large irreversible losses below -60°C	-0.19% per °C
Alnico	550	Permanent losses no more than 10% expected down to -269°C	-0.02% per °C
Samarium Cobalt	300	Minimal losses down to -269°C	-0.003% per °C
Neodymium	80*	No irreversible losses down to -196°C	-0.12% per °C

*N35 grade. Other grades available up to 230°C

Other Factors To Consider

Corrosion

Another potential cause of performance loss is a breakdown of the magnet's composition due to corrosive environmental effects. This table shows relative corrosive resistance for each material when uncoated. As neodymium's corrosive resistance is poor it is usually sold with a protective coating, normally either nickel or zinc.

External Demagnetising Fields / Magnet Stability

Temperature has the greatest effect on magnet stability but high external magnetic fields can influence performance. This table shows the relative demagnetising effect on each material.

Magnet Material	Corrosion Resistance Uncoated	Resistance To Demagnetisation
Ferrite	Excellent	High
Alnico	Fair	Low
Samarium Cobalt	Excellent	Very High
Neodymium	Poor	Very High

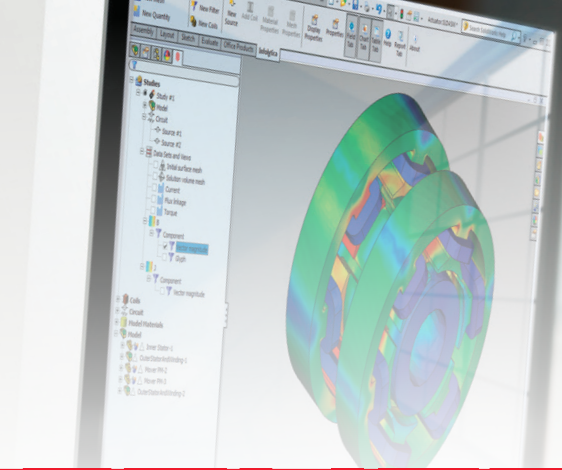

Magnetic field flowing across an air gap?

Single pole operation (bar, block, disc and ring magnet)

When a depth of field is required for attracting, switching or actuating across an air gap, use a single piece of magnet.

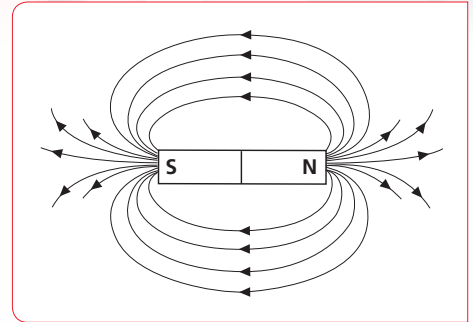

Single pole operation magnet flux crosses a gap but has a diminishing strength field.

Pot Magnets

Both north and south pole are on one face of the magnet, similar to button and horseshoe magnets.

The magnetic material is encased inside a steel pot. The pot is part of the magnetic circuit. The poles are concentric.

The depth of the magnetic field is shallower than that of magnets with poles further apart, e.g. horseshoe magnets, but grip in intimate contact is generally superior.

Maximum operating temperature of pots is lower than the magnet material used because of the different thermal expansion rates of the material and the pot. Exposure to temperatures higher than the recommended maximum can cause units to come apart.

Button Magnet

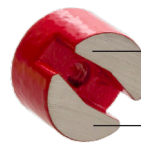

North Pole

South Pole

Horseshoe Magnet

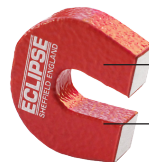

North Pole

South Pole

Other Features

- No stray flux as magnetism is retained in a closed circuit
- Pot screens magnet material from demagnetising effects
- Pot is machinable
- Can be inserted into steel without adverse effects (not the case with unscreened magnets)

Clamping, Holding or Lifting

- Two pole operation (Horseshoe, button or pot magnet)
- Two pole or multi-pole magnets are designed for holding, clamping or lifting when in direct contact with a ferro-magnetic surface.

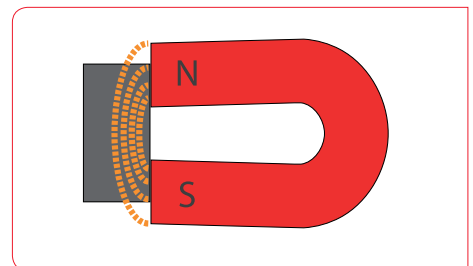

Please note, this guide provides general information only.
For specific information on bespoke products or applications please contact us on +44 (0)114 225 0600

Two pole operation magnet flux does not travel as far but is stronger

Customised Magnetic Solutions

If you cannot find a product in this catalogue suitable for your application, we can work with you to provide a customised solution.*

From Stage 1 To Project Completion

Many businesses are looking to add a competitive edge to their products or manufacturing processes. With our facilities and expertise we can tackle the most challenging of bespoke applications. We work closely with customers to understand their application, then to design, develop and produce a customised magnetic assembly.

Application Consultation

Our team can visit your site to understand the application and give advice.

Design & Prototyping

Using the latest software, our design team provide 3D designs, 3D FEA and trial prototypes.

Magnet Fabrication

Customised manufacture in a range of materials to customer specifications of shape, size, housings and magnetic intensity.

Magnet Stabilisation

For applications where consistent performance is critical we can ensure that magnet flux values are stabilised

Rotor Balancing

Ensures total concentricity for rotating magnet applications.

Machining Facilities

Micron accurate internal and external grinding facilities ensure that customised magnets are produced to high precision specifications.

Choice of Materials

We can offer the complete range of magnet materials to suit different application and operating conditions.

*Subject to quantities

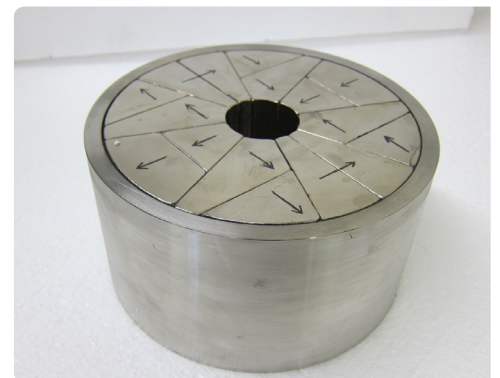
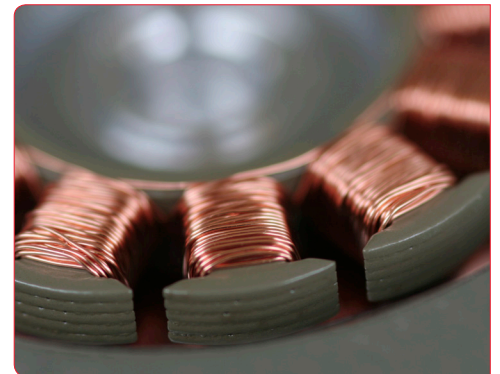

Contact Us

If you have a project you would like to discuss, please contact us via:

+44 (0)114 225 0600

+44 (0)114 225 0610

www.eclipsemagnetics.com

info@eclipsemagnetics.com

Eclipse Magnetics Ltd
Atlas Way, Sheffield, S4 7QQ, England



Eclipse Magnetics Worldwide

Europe

Atlas Way
Sheffield
S4 7QQ
England

T +44 (0)114 225 0600
F +44 (0)114 225 0610
sales@eclipsemagnetics.com

Americas

442 Millen Road, Unit 9,
Stoney Creek
Ontario, L8E 6H2,
Canada

T +1 905-664-5585
F +1 905-664-7090
sales@eclipsetoolsinc.com

China

No. 168 Chengjian Road
Minhang District
Shanghai
PR China

T +86 21 6434 8600 *150
F +86 21 6434 6488
szhou@eclipsemagnetics.com

Australia

PO BOX 4400
Dandenong South
Victoria 3175
Australia

T +613 8792-9999
F +613 8792-9900
sales@spear-and-jackson.com.au

Representative:

www.eclipsemagnetics.com

Eclipse Magnetics Ltd

Atlas Way, Sheffield, S4 7QQ, England

☎ +44 (0)114 225 0600

📠 +44 (0)114 225 0610

🔍 www.eclipsemagnetics.com

✉ info@eclipsemagnetics.com

While every effort has been made to ensure the accuracy of the information within this publication, please note that specifications may change without notice.